

THE BOOK OF MEINL PERCUSSION 2025





# WHAT'S NEW IN 2025



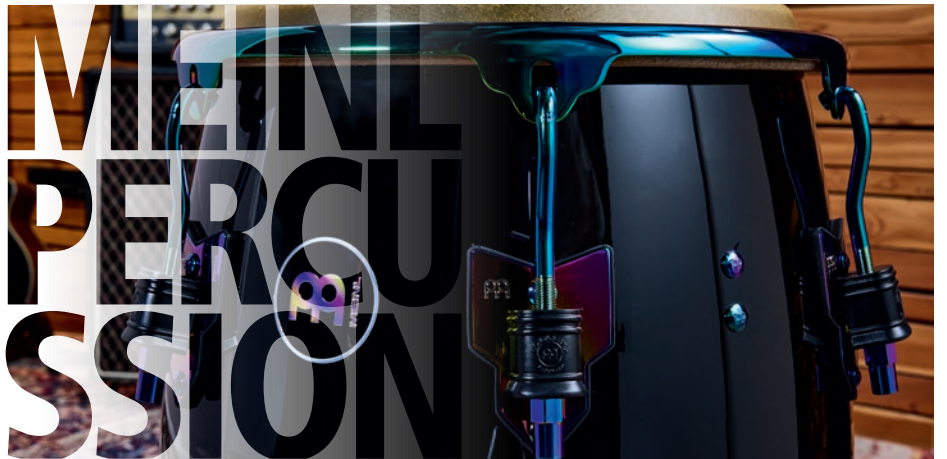

---

## B

Bags	126
Blocks	36
Bongos	20

---

## C

Cabasas	37
Cajons	40
Castanets	91
Chimes	94
Claves	34
Congas	06
Cowbells	29
Culture Instruments	109

---

## D

Darbukas	110
Didgeridoos	96
Djembes	62
Doumbeks	111

---

## F

Foot Percussion	56
Frame Drums	82

---

## G

Güiros	34
--------	----

---

## H

Hardware	114
----------	-----

---

## K

Kalimbas	91
----------	----

---

## M

Maracas	35
Merenge Güiras	37

---

## R

Rainsticks	98
------------	----

---

## S

Samba	101
Shakers	55 / 86 / 101
Sound Effects	92
Sticks/Beaters	124

---

## T

Tambourines	74 / 87
Timbales	25

# CONGAS

The conga is more than just a drum; it's a vessel of history and emotion. Its story begins in the heart of Africa, where drums were crafted to celebrate and connect communities. Over time, it evolved into a powerful symbol of identity and expression, blending African rhythms with Spanish and indigenous influences. The conga became the heartbeat of Afro-Cuban music.

Meinl Percussion Congas represents tradition combined with exceptional craftsmanship. We produce these premium drums using only the finest hand-selected materials. We collaborate closely with the most sought-after Conga players on a daily basis, drawing on their expertise to fine-tune every aspect of our drums and make sure that we ensure the highest quality sound and performance.

When you hear the deep, resonant tones of a Meinl Percussion Conga, you're not just hearing a drum; you're feeling the rhythm that has connected generations.





# CONGA HEADS & MINI CONGAS

1



The REMO® Symmetry Conga Heads add more volume and resonance to your Conga. These are available for congas with this sign.



Black Calfskin Skydeep® **RHEAD-11BK**    Black Calfskin Skydeep® **RHEAD-1134BK**    Black Calfskin Skydeep® **RHEAD-1212BK**



Black Calfskin Skydeep® **RTHEAD-11BK**    Black Calfskin Skydeep® **RTHEAD-1134BK**    Black Calfskin Skydeep® **RTHEAD-1212BK**



Fiberskyn® **RHEAD-11NT**    Fiberskyn® **RHEAD-1134NT**    Fiberskyn® **RHEAD-1212NT**



Nuskyn® **RTHEAD-11NS**    Nuskyn® **RTHEAD-1134NS**    Nuskyn® **RTHEAD-1212NS**

2



Natural, 4 1/2" **MC100NT**

Vintage Wine Barrel, 4 1/2" **MC100VWB**

Wine Red, 4 1/2" **MC100WR**

3



**CONGA-SAVER8**    **CONGA-SAVER10**

4



COMES IN A SET OF 4

Set **MCR-BK**

5

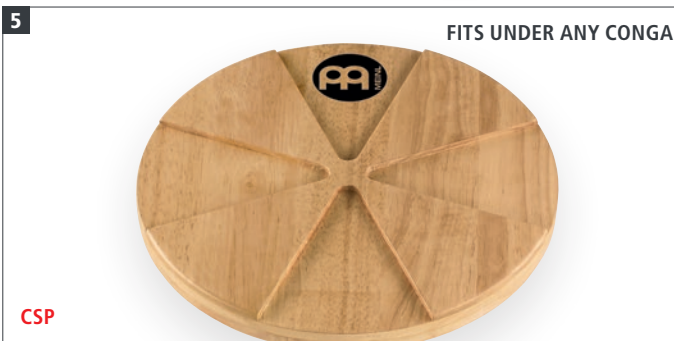

FITS UNDER ANY CONGA

**CSP**

## 1 REMO® SYMMETRY CONGA HEADS

**SIZES** **RHEAD-11:** 11" Quinto; SSR-Rim  
**RHEAD-1134:** 11 3/4" Conga; SSR-Rim  
**RHEAD-1212:** 12 1/2" Tumba; SSR-Rim  
**RTHEAD-11:** 11" Quinto; TTR-Rim  
**RTHEAD-1134:** 11 3/4" Conga; TTR-Rim  
**RTHEAD-1212:** 12 1/2" Tumba; TTR-Rim  
**FIT FOR** **RHEAD:** MCC, MEC, MP, FC, MSA, WKT, WCO, BWC, DG, RS, S  
**RTHEAD:** LC, MTC  
**FEATURE** For more volume and resonance  
**FINISHES** **BK:** Black Calfskin Skydeep®  
**NS:** Nuskyn®  
**NT:** Fiberskyn®

**FEATURES** Contains every feature of a regular Meinl conga, at 2/5 the size  
Tunable buffalo skin head with 4 chrome lugs and rounded rim  
Great for spontaneous jam sessions or drum circles  
**COLOURS** **NT:** Natural  
**VWB:** Vintage Wine Barrel  
**WR:** Wine Red

## 3 CONGA SAVERS

**SIZES** **CONGA-SAVER8:** for 8 mm tuning lugs  
**CONGA-SAVER10:** for 10 mm tuning lugs  
**FEATURES** Placed over the conga lugs to prevent them from damaging and scratching the shell  
Conga remains fully tunable

## 4 CONGA RISERS

**MATERIAL** Sturdy rubber  
**FEATURES** Raise your drums off the floor to allow maximum sound projection  
Provide a stable base on any surface  
Come in a set of four  
Flexible construction  
**COLOUR** **BK:** Black

## 5 CONGA SOUND PLATE

**SIZE** 13 1/4"  
**MATERIAL** Siam Oak (*Hevea brasiliensis* Muell.-Arg.)  
**FEATURE** Provides a hard sound reflective surface under your conga



# SPECTRUM & WOODCRAFT CONGAS



**6** **NEW** **REMO HEADS AVAILABLE** **PHANTOM BLACK**

11" **S11PBK**      11 3/4" **S1134PBK**      12 1/2" **S1212PBK**

**7** **REMO HEADS AVAILABLE** **VINTAGE BLACK**

11" **WCO11VBK-M**      11 3/4" **WCO1134VBK-M**      12 1/2" **WCO1212VBK-M**

**VINTAGE BROWN**

11" **WCO11VBR-M**      11 3/4" **WCO1134VBR-M**      12 1/2" **WCO1212VBR-M**

**VINTAGE RED**

11" **WCO11VR-M**      11 3/4" **WCO1134VR-M**      12 1/2" **WCO1212VR-M**

CONGAS

## 6 SPECTRUM SERIES CONGAS

- SIZES** **S11:** 11" Quinto, 30" tall  
**S1134:** 11 3/4" Conga, 30" tall  
**S1212:** 12 1/2" Tumba, 30" tall
- MATERIALS** Three ply Siam Oak  
*(Hevea brasiliensis Muell.-Arg.)*  
 True Skin Buffalo Heads
- FEATURES** 10 mm strong tuning lugs  
 4 mm rounded SSR-Rims  
 Spectrum Series hardware
- INCLUDES** Meinl Conga Savers  
 Meinl Conga Handle  
 Meinl Soundpads  
 Accessory pouch  
 L-shaped tuning key  
 Tune Up Oil
- COLOUR** **PBK:** Phantom Black

## 7 WOODCRAFT SERIES WCO CONGAS

- SIZES** **WCO11:** 11" Quinto, 30" tall  
**WCO1134:** 11 3/4" Conga, 30" tall  
**WCO1212:** 12 1/2" Tumba, 30" tall
- MATERIALS** Three ply American White Ash  
*(Fraxinus americana L.)*  
 True Skin Buffalo Heads
- FEATURES** 10 mm strong tuning lugs  
 4 mm rounded SSR-Rims  
 Chrome plated hardware
- INCLUDES** Meinl Conga Savers  
 Meinl Conga Handle  
 Meinl Soundpads  
 Accessory pouch  
 L-shaped tuning key  
 Tune Up Oil
- COLOURS** **VBK-M:** Vintage Black  
**VBR-M:** Vintage Brown  
**VR-M:** Vintage Red
- FINISH** Matte

## PROFESSIONAL CONGA STAND WITH WHEELS (SEE PAGE 115)



**TMPC**

# SIGNATURE CONGAS

**1** **NEW** REMO® BLACK CALFSKIN SKYNDDEEP® HEADS



11" **WKT11BW**      11 3/4" **WKT1134BW**      12 1/2" **WKT1212BW**

**NEW** REMO® BLACK CALFSKIN SKYNDDEEP® HEADS



11" **WKT11ES**      11 3/4" **WKT1134ES**      12 1/2" **WKT1212ES**

From Santurce, Puerto Rico, **William Kachiro Thompson** is one of the most in-demand conga and bongo players today. As a prolific recording and touring artist, Kachiro needs drums that will deliver in a wide variety of musical situations. Inside or outside, in an intimate venue or a big stadium, in the studio or while on tour, Kachiro needs instruments that feel good when he plays them and that transmit the nuances and intensity of his playing. With more than 500 recordings during his career so far, Kachiro's sound and playing style has become a staple in modern-day salsa music produced in the salsa capitals of the world, like San Juan (Puerto Rico), Miami, and New York. The Artist Series Congas and Bongos by MEINL are just what Kachiro needs in terms of look and sound. With an elegant shape of the drum, these drums will accompany Kachiro during his busy recording and playing schedule, always delivering the sound he needs.



Kachiro Thompson

**1** **WILLIAM "KACHIRO" THOMPSON SIGNATURE CONGAS**

**SIZES** **WKT11:** 11" Quinto, 30" tall  
**WKT1134:** 11 3/4" Conga, 30" tall  
**WKT1212:** 12 1/2" Tumba, 30" tall

**MATERIALS** REMO® Black Calfskin Skynddeep® Heads  
**BW:** Three ply New Zealand Pine Wood  
**ES:** Premium Fiberglass

**FEATURES** 10 mm strong tuning lugs  
 4 mm rounded SSR-Rims  
 Chrome plated hardware

**INCLUDES** Meinl Conga Savers  
 Meinl Conga Handle  
 Meinl Soundpads  
 Accessory pouch  
 L-shaped tuning key  
 Tune Up Oil

**COLOURS** **BW:** Blue Wave  
**ES:** Electric Sky

**WILLIAM "KACHIRO" THOMPSON SIGNATURE BONGOS (SEE PAGE 20)**



**WKT400BW**

**WKT400ES**



Latin grammy winner, producer, composer, musician and percussianist **Diego Galé** has devoted his artistic life to the knowledge of Afro-Cuban music to integrate it with his special way of creating music with flavor. Diego started playing on bongos at an early age, later adding congas. The Meinl Percussion Diego Galé Artist Series instruments are just what Diego needs in terms of comfort, look, and sound. Their sound is rich and dynamic, full of popping highs and warm lows for both studios and live situations.

*Diego Galé*

**2** **REMO® BLACK CALFSKIN SKYNDEEP® HEADS** **REMO® FIBERSKYN® HEADS**



**NEW**



11" **DG11MS**      11 3/4" **DG1134MS**      12 1/2" **DG1212MS**



11" **DGR11CW**      11 3/4" **DGR1134CW**      12 1/2" **DGR1212CW**

**2 DIEGO GALÉ SIGNATURE CONGAS**

- SIZES**  
**DG11:** 11" Quinto, 28" tall  
**DG1134:** 11 3/4" Conga, 28" tall  
**DG1212:** 12 1/2" Tumba, 28" tall  
**DGR11:** 11" Quinto, 30" tall  
**DGR1134:** 11 3/4" Conga, 30" tall  
**DGR1212:** 12 1/2" Tumba, 30" tall
- MATERIALS**  
**DG:** Premium Fiberglass  
 REMO® Black Calfskin Skyndeeep® Heads  
**DGR:** Two ply Chamchuri Wood  
 REMO® Fiberskyn® Heads
- FEATURES**  
 10 mm strong tuning lugs  
 4 mm rounded SSR-Rims  
**DG:** Chrome plated hardware  
**DGR:** Brushed nickel hardware

- INCLUDES** Meinl Conga Savers  
 Meinl Conga Handle  
 Meinl Soundpads  
 Accessory pouch  
 L-shaped tuning key  
 Tune Up Oil
- COLOURS** **CW:** Chamchuri Wood  
**MS:** Midnight Star
- FINISH** **CW:** High gloss

**DIEGO GALÉ SIGNATURE BONGOS**  
(SEE PAGE 20)



**DG400MS**



**DGR400CW**

# SIGNATURE CONGAS

**1** **NEW** REMO® FIBERSKYN® HEADS

REMO HEADS AVAILABLE



11" **RS11PW**      11 3/4" **RS1134PW**      12 1/2" **RS1212PW**



Grammy nominated artist **Roberto Serrano** is a recognized Mexican percussionist and drummer whose constant search for musical excellence has allowed him the privilege of working with highly recognized musicians like Alvaro Lopez, Michael Landau, Abraham Laboriel and John Peña. Currently Roberto is playing with Luis Miguel a Mexican singer and record producer. His Artist Series signature congas are specially designed with Roberto Serrano. Outfitted with REMO® Fiberskyn Heads and features a Pearl White finish. Available as 11" quinto, 11 3/4" conga, 12 1/2" tumba.

*Roberto Serrano Cruz*



**Ramon Mongo Santamaria** was without a doubt one of the most respected conga players ever, and a pioneer of modern Latin Jazz. Ramon recorded dozens of legendary percussion albums. Mongo has inspired more percussionists around the globe than any other conguero. Mongo Santamaria died at the Baptist Hospital in Miami, USA in February 2003. He was 85 years old. It is with great appreciation and deepest respect that we honour our friend and his life's work with his MEINL Artist Series Mongo Santamaria Congas.

*Ramon Mongo Santamaria*

**2** REMO® TRUE SKIN BUFFALO HEADS

REMO HEADS AVAILABLE



11" **MSA11AWA**      11 3/4" **MSA1134AWA**      12 1/2" **MSA1212AWA**

**1** **ROBERTO SERRANO SIGNATURE CONGAS**

**SIZES** **RS11:** 11" Quinto, 30" tall  
**RS1134:** 11 3/4" Conga, 30" tall  
**RS1212:** 12 1/2" Tumba, 30" tall

**MATERIALS** Three ply Siam Oak  
(*Hevea brasiliensis* Muell.-Arg.)  
REMO® Fiberskyn® Heads

**FEATURES** 10 mm strong tuning lugs  
4 mm rounded SSR-Rims  
Brushed nickel hardware

**INCLUDES** Meinl Conga Savers  
Meinl Conga Handle  
Meinl Soundpads  
Accessory pouch  
L-shaped tuning key  
Tune Up Oil

**COLOUR** **PW:** Pearl White

**2** **RAMON "MONGO" SANTAMARIA SIGNATURE CONGAS**

**SIZES** **MSA11:** 11" Quinto, 30" tall  
**MSA1134:** 11 3/4" Conga, 30" tall  
**MSA1212:** 12 1/2" Tumba, 30" tall

**MATERIALS** Two ply American White Ash  
(*Fraxinus americana* L.)  
True Skin Buffalo Heads

**FEATURES** 10 mm strong tuning lugs  
4 mm rounded SSR-Rims  
Gold tone hardware

**INCLUDES** Meinl Conga Savers  
Meinl Conga Handle  
Meinl Soundpads  
Accessory pouch  
L-shaped tuning key  
Tune Up Oil

**COLOUR** **AWA:** American White Ash  
**FINISH** High gloss

**ROBERTO SERRANO SIGNATURE BONGO (SEE PAGE 20)**



**RS400PW**

3

REMO  
HEADS  
AVAILABLE

TRUE SKIN BUFFALO HEADS



11"  
LC11NT-M

11 3/4"  
LC1134NT-M

12 1/2"  
LC1212NT-M

REMO® NUSKYN® HEADS



11"  
LCR11NT-M

11 3/4"  
LCR1134NT-M

12 1/2"  
LCR1212NT-M

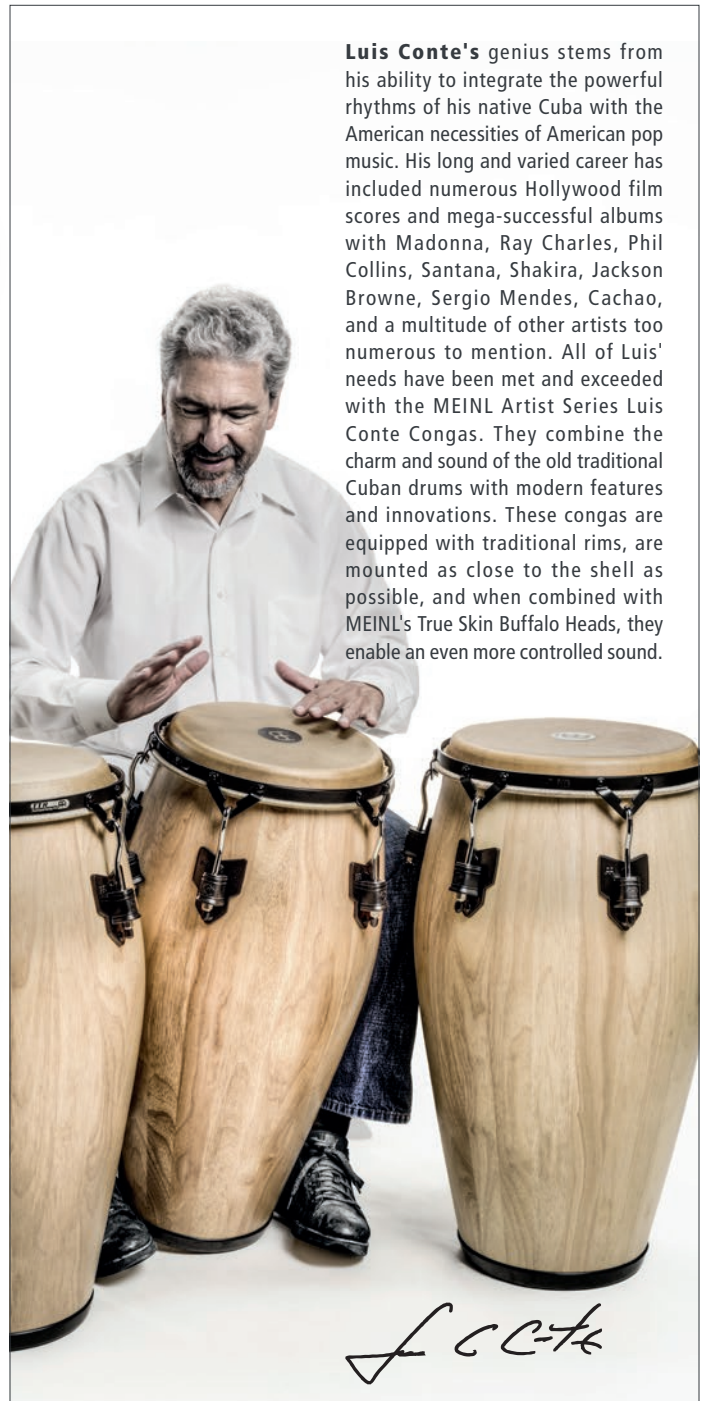

**Luis Conte's** genius stems from his ability to integrate the powerful rhythms of his native Cuba with the American necessities of American pop music. His long and varied career has included numerous Hollywood film scores and mega-successful albums with Madonna, Ray Charles, Phil Collins, Santana, Shakira, Jackson Browne, Sergio Mendes, Cachao, and a multitude of other artists too numerous to mention. All of Luis' needs have been met and exceeded with the MEINL Artist Series Luis Conte Congas. They combine the charm and sound of the old traditional Cuban drums with modern features and innovations. These congas are equipped with traditional rims, are mounted as close to the shell as possible, and when combined with MEINL's True Skin Buffalo Heads, they enable an even more controlled sound.

CONGAS

3 LUIS CONTE SIGNATURE CONGAS

**SIZES** **LC(R)11:** 11" Quinto, 30" tall  
**LC(R)1134:** 11 3/4" Conga, 30" tall  
**LC(R)1212:** 12 1/2" Tumba, 30" tall

**MATERIALS** Two ply Siam Oak  
(*Hevea brasiliensis* Muell.-Arg.)  
**LC:** True Skin Buffalo Heads  
**LCR:** REMO® Nuskyn® Heads

**FEATURES** 8 mm strong tuning lugs  
5 mm traditional TTR-Rims  
Black powder coated hardware

**INCLUDES** Meinl Conga Savers  
Meinl Soundpads  
Accessory pouch  
L-shaped tuning key  
Tune Up Oil

**COLOUR** **NT:** Natural  
**FINISH** Matte

LUIS CONTE SIGNATURE BONGOS  
(SEE PAGE 20)



LC300NT-M



LCR300NT-M

# WOODCRAFT TRADITIONAL & FLOATUNE CONGAS

1

ZEBRA FINISHED ASH



11"  
WC11ZFA-M

11 3/4"  
WC1134ZFA-M

12 1/2"  
WC1212ZFA-M

PROFESSIONAL CONGA BAGS  
(SEE PAGE 127)



MCOB-11

MCOB-1134

MCOB-1212

2

NATURAL



10"  
FL10NT

11"  
FL11NT

12"  
FL12NT

13"  
FL13NT

THE FLOATUNE TUNING SYSTEM  
ALLOWS THE SHELL TO  
VIBRATE FREELY



## 1 WOODCRAFT TRADITIONAL SERIES CONGAS

**SIZES** WC11: 11" Quinto, 30" tall  
WC1134: 11 3/4" Conga, 30" tall  
WC1212: 12 1/2" Tumba, 30" tall

**MATERIALS** Three ply American White Ash (*Fraxinus americana* L.)  
True Skin Buffalo Heads

**FEATURES** 10 mm strong tuning lugs  
5 mm traditional TTR-Rims  
Chrome plated hardware

**INCLUDES** Meinl Conga Savers  
Meinl Conga Handle  
Meinl Soundpads  
Accessory pouch  
L-shaped tuning key  
Tune Up Oil

**COLOUR** Zebra Finished Ash  
**FINISH** Matte

## 2 FLOATUNE SERIES CONGAS

**SIZES** FL10: 10" Nino, 30" tall  
FL11: 11" Quinto, 30" tall  
FL12: 12" Conga, 30" tall  
FL13: 13" Tumba, 30" tall

**MATERIALS** Two ply Siam Oak (*Hevea brasiliensis* Muell.-Arg.)  
True Skin Buffalo Heads

**FEATURES** Floatune Tuning System  
10 mm strong tuning lugs  
4 mm rounded SSR-Rims  
Chrome plated hardware

**INCLUDES** Meinl Conga Savers  
Meinl Conga Handle  
Meinl Soundpads  
Accessory pouch  
L-shaped tuning key  
Tune Up Oil

**COLOUR** Natural  
**FINISH** High gloss

# PROFESSIONAL & FIBERCRAFT CONGAS



**3** **REMO HEADS AVAILABLE**

**NATURAL** **BROWN BURL**

11" **MP11NT**      11 3/4" **MP1134NT**      12 1/2" **MP1212NT**      11" **MP11BB**      11 3/4" **MP1134BB**      12 1/2" **MP1212BB**

**4** **REMO HEADS AVAILABLE**

**TRUE SKIN BUFFALO HEADS** **REMO® BLACK CALFSKIN SKYNDDEEP® HEADS**

11" **FC11BK**      11 3/4" **FC1134BK**      12 1/2" **FC1212BK**      11" **FCR11BK**      11 3/4" **FCR1134BK**      12 1/2" **FCR1212BK**

CONGAS

### 3 PROFESSIONAL SERIES CONGAS

- SIZES** **MP11:** 11" Quinto, 30" tall  
**MP1134:** 11 3/4" Conga, 30" tall  
**MP1212:** 12 1/2" Tumba, 30" tall
- MATERIALS** Two ply Siam Oak  
*(Hevea brasiliensis Muell.-Arg.)*  
 True Skin Buffalo Heads
- FEATURES** 10 mm strong tuning lugs  
 4 mm rounded SSR-Rims  
 Chrome plated hardware
- INCLUDES** Meinl Conga Savers  
 Meinl Conga Handle  
 Meinl Soundpads  
 Accessory pouch  
 L-shaped tuning key  
 Tune Up Oil
- COLOURS** **BB:** Brown Burl  
**NT:** Natural
- FINISH** High gloss

### 4 FIBERCRAFT SERIES CONGAS

- SIZES** **FC(R)11:** 11" Quinto, 30" tall  
**FC(R)1134:** 11 3/4" Conga, 30" tall  
**FC(R)1212:** 12 1/2" Tumba, 30" tall
- MATERIALS** Premium fiberglass  
**FC:** True Skin Buffalo Heads  
**FCR:** Remo® Black Calfskin Skynddeep® Heads
- FEATURES** 10 mm strong tuning lugs  
 4 mm rounded SSR-Rims  
 Chrome plated hardware
- INCLUDES** Meinl Conga Savers  
 Meinl Conga Handle  
 Meinl Soundpads  
 Accessory pouch  
 L-shaped tuning key  
 Tune Up Oil
- COLOUR** **BK:** Black

### REMO® SYMMETRY CONGA HEADS (SEE PAGE 06)



The REMO® Symmetry Conga Heads add more volume and resonance to your Conga. These are available for congas with this sign.



# MARATHON® EXCLUSIVE & TRADITIONAL CONGAS



11"  
MEC11NT-CH

11 3/4"  
MEC1134NT-CH

12 1/2"  
MEC1212NT-CH

11"  
MECR11NT-CH

11 3/4"  
MECR1134NT-CH

12 1/2"  
MECR1212NT-CH

11"  
MEC11NT-G

11 3/4"  
MEC1134NT-G

12 1/2"  
MEC1212NT-G

11"  
MEC11WRP-CH

11 3/4"  
MEC1134WRP-CH

12 1/2"  
MEC1212WRP-CH

## MARATHON® SERIES CONGAS

1 2 3 4

**PATENTS** Steely-Il patents:  
L-shaped leg and metal spike attachment (DE, TH, US patent)  
U-shaped notch (US patent)  
Ergonomic arched rubber bracing (CN, DE, TH, US patent)  
Notches for quick height adjustability (DE patent)

## 1 MARATHON® EXCLUSIVE SERIES CONGAS

**SIZES** **MEC(R)11:** 11" Quinto, 30" tall  
**MEC(R)1134:** 11 3/4" Conga, 30" tall  
**MEC(R)1212:** 12 1/2" Tumba, 30" tall  
**MATERIALS** **MEC(R)11NT, MEC(R)1134NT, MEC(R)1212NT:** Two ply Siam Oak (*Hevea brasiliensis* Muell.-Arg.)

**MEC11WRP, MEC1134WRP, MEC1212WRP:** Two ply New Zealand Pine Wood  
**MEC:** True Skin Buffalo Heads  
**MECR:** REMO® Fiberskyn® Heads  
**FEATURES** 8 mm strong tuning lugs  
2.6 mm rounded SSR-Rims  
**CH:** Chrome plated hardware  
**G:** Gold tone hardware  
**INCLUDES** Steely II Conga Stand (patented)  
Meinl Conga Savers  
Meinl Conga Handle  
Meinl Sound Pads  
Accessory pouch  
L-shaped tuning key  
Tune Up Oil  
**COLOURS** **NT:** Natural  
**WR:** Wine Red  
**FINISH** High gloss

## 2 MARATHON® TRADITIONAL SERIES CONGAS

**SIZES** **MTCR11:** 11" Quinto, 30" tall  
**MTCR1134:** 11 3/4" Conga, 30" tall  
**MTCR1212:** 12 1/2" Tumba, 30" tall  
**MATERIALS** Two ply Siam Oak (*Hevea brasiliensis* Muell.-Arg.)  
REMO® Black Calfskin Skyndee® Heads  
**FEATURES** 8 mm strong tuning lugs  
5 mm traditional TTR-Rims  
Black powder coated hardware  
**INCLUDES** Steely II Conga Stand (patented)  
Meinl Conga Savers  
Meinl Conga Handle  
Meinl Sound Pads  
Accessory pouch  
L-shaped tuning key  
Tune Up Oil  
**COLOUR** **WR:** Wine Red  
**FINISH** High gloss



# MARATHON® DESIGNER & CLASSIC CONGAS



**2** **REMO HEADS AVAILABLE**

**REMO® BLACK CALFSKIN SKYNDEEP® HEADS**

11" **MTCR11WR**      11 3/4" **MTCR1134WR**      12 1/2" **MTCR1212WR**

**3** **REMO HEADS AVAILABLE**

**TRUE SKIN BUFFALO HEADS**

11" **MCC11LB**      11 3/4" **MCC1134LB**      12 1/2" **MCC1212LB**

**4** **REMO HEADS AVAILABLE**

**NATURAL**

11" **MCC11NT**      11 3/4" **MCC1134NT**      12 1/2" **MCC1212NT**

**SUPER NATURAL**

11" **MCC11SNT-M**      11 3/4" **MCC1134SNT-M**      12 1/2" **MCC1212SNT-M**

**COFFEE BURST**

11" **MCC11CB**      11 3/4" **MCC1134CB**      12 1/2" **MCC1212CB**

### 3 MARATHON® DESIGNER SERIES CONGAS

- SIZES** **MCC11:** 11" Quinto, 30" tall  
**MCC1134:** 11 3/4" Conga, 30" tall  
**MCC1212:** 12 1/2" Tumba, 30" tall
- MATERIALS** Two ply Siam Oak  
*(Hevea brasiliensis Muell.-Arg.)*  
 True Skin Buffalo Heads
- FEATURES** 8 mm strong tuning lugs  
 2.6 mm rounded SSR-Rims  
 Black powder coated hardware
- INCLUDES** Steely II Conga Stand (patented)  
 Meinl Conga Savers  
 Accessory pouch  
 L-shaped tuning key  
 Tune Up Oil
- COLOUR FINISH** **LB:** Leopard Burl High gloss

### 4 MARATHON® CLASSIC SERIES CONGAS

- SIZES** **MCC11:** 11" Quinto, 30" tall  
**MCC1134:** 11 3/4" Conga, 30" tall  
**MCC1212:** 12 1/2" Tumba, 30" tall
- MATERIALS** Two ply Siam Oak  
*(Hevea brasiliensis Muell.-Arg.)*  
 True Skin Buffalo Heads
- FEATURES** 8 mm strong tuning lugs  
 2.6 mm rounded SSR-Rims  
 Black powder coated hardware
- INCLUDES** Steely II Conga Stand (patented)  
 Meinl Conga Savers  
 Accessory pouch  
 L-shaped tuning key  
 Tune Up Oil
- COLOURS** **CB:** Coffee Burst, high gloss  
**NT:** Natural, high gloss  
**SNT-M:** Super Natural, matte

### REMO® SYMMETRY CONGA HEADS (SEE PAGE 06)



The REMO® Symmetry Conga Heads add more volume and resonance to your Conga. These are available for congas with this sign.



# HEADLINER® & HEADLINER® TRADITIONAL CONGAS



## 1 HEADLINER® SERIES CONGAS

<b>SIZES</b>	<b>HC10:</b> 10" Nino, 28" tall <b>HC11:</b> 11" Quinto, 28" tall <b>HC12:</b> 12" Conga, 28" tall
<b>MATERIALS</b>	Siam Oak ( <i>Hevea brasiliensis</i> Muell.-Arg.) Hand selected buffalo heads
<b>FEATURES</b>	8 mm strong tuning lugs Original Meinl style tuning brackets 2 mm rounded rims Black powder coated hardware
<b>INCLUDES</b>	Height adjustable basket stands (patented) with quick set up system Tuning key
<b>COLOURS</b>	<b>PBK-M:</b> Phantom Black <b>SNT-M:</b> Super Natural <b>VWB-M:</b> Vintage Wine Barrel
<b>FINISH</b>	Matte

**PATENTS** Basket stand patents:  
Ergo arched rubber bracing (CN, DE, TH, US patent)  
U-shaped notch (US patent)  
L-shaped leg (DE patent)

## 2 HEADLINER® TRADITIONAL SERIES CONGAS

<b>SIZES</b>	<b>HTC10:</b> 10" Nino, 28" tall <b>HTC11:</b> 11" Quinto, 28" tall <b>HTC12:</b> 12" Conga, 28" tall
<b>MATERIALS</b>	Siam Oak ( <i>Hevea brasiliensis</i> Muell.-Arg.) Hand selected buffalo heads
<b>FEATURES</b>	8 mm strong tuning lugs Original Meinl style tuning brackets 5 mm traditional TTR-Rims Black powder coated hardware
<b>INCLUDES</b>	Height adjustable basket stands (patented) with quick set up system Tuning key
<b>COLOUR</b>	<b>WB-M:</b> Walnut Brown
<b>FINISH</b>	Matte
<b>PATENTS</b>	Basket stand patents: Ergo arched rubber bracing (CN, DE, TH, US patent) U-shaped notch (US patent) L-shaped leg (DE patent)

# HEADLINER® CONGA SETS



3



Set, 10" & 11"  
**HC555NT**



Set, 11" & 12"  
**HC512NT**

NATURAL



Set, 10" & 11"  
**HC555VSB**

VINTAGE SUNBURST



Set, 10" & 11"  
**HC888NT**

THE BONGO MOUNT IS EASY MOUNTABLE ON OUR CONGA DOUBLE STANDS (SEE PAGE 114)



THBM



Set, 11" & 12"  
**HC512VSB**



Set, 11" & 12"  
**HC812NT**



Set, 10" & 11"  
**HC888VSB**



Set, 11" & 12"  
**HC812VSB**

## 3 HEADLINER® SERIES CONGA SETS

- SIZES** **HC555, HC888:**  
10" Nino & 11" Quinto, 28" tall  
**HC512, HC812:**  
11" Quinto & 12" Conga, 28" tall
- MATERIALS** Siam Oak (*Hevea brasiliensis* Muell.-Arg.)  
Hand selected buffalo heads
- FEATURES** 8 mm strong tuning lugs  
Original Meinl style tuning brackets  
2 mm rounded rims  
Black powder coated hardware
- INCLUDES** Tuning key  
**HC555, HC512:** Height adjustable basket stands (patented) with quick set up system  
**HC888, HC812:** Height adjustable double braced tripod stand
- COLOURS** **NT:** Natural  
**VSB:** Vintage Sunburst
- FINISH** High gloss

- PATENTS** Basket stand patents:  
Ergo arched rubber bracing (CN, DE, TH, US patent)  
U-shaped notch (US patent)  
L-shaped leg (DE patent)

CONGAS

# BONGGOS





The bongo drum is a little instrument with a tremendous soul. Its roots can be found in the vibrant streets of Cuba, where indigenous, Spanish, and African sounds blended to create a vibrant musical tapestry. The larger drum, the "hembra", and the smaller drum, the "macho", add vitality to the song by making bright, crisp sounds that cut through the atmosphere.

Meinl bongos are expertly made with a commitment to quality, fusing imagination and accuracy. Our bongos guarantee to enhance each beat and stimulate your musical journey, regardless of your level of experience with drumming – whether you're a beginner learning the art or an accomplished performer honing your craft.

# BONGO HEADS & BONGOS

**1**

**REMO HEADS AVAILABLE**

The REMO® R-Series Bongo Heads add more volume and resonance to your Bongo. These are available for bongos with this sign.



Fiberskyn®  
**RHEAD-7NT**

Fiberskyn®  
**RHEAD-812NT**

Nuskyn®  
**RHEAD-7NS**

Nuskyn®  
**RHEAD-812NS**

Black Calfskin Skyndeeep®  
**RHEAD-7BK**

Black Calfskin Skyndeeep®  
**RHEAD-812BK**

**2**

**REMO HEADS AVAILABLE**

**NEW**



Natural, matte, 6 3/4" & 8"  
**LC300NT-M**

Natural, matte, 6 3/4" & 8"  
**LCR300NT-M**

*L. Conte*

TRADITIONAL TTR-RIM

**3**

**REMO HEADS AVAILABLE**

**NEW**



Midnight Star, 7" & 8 1/2"  
**DG400MS**

Natural, high gloss, 7" & 8 1/2"  
**DGR400CW**

*Diego Galé*

**4**

**REMO HEADS AVAILABLE**

**NEW**



Blue Wave, 7" & 8 1/2"  
**WKT400BW**

Electric Sky, 7" & 8 1/2"  
**WKT400ES**

*Kachiro Thompson*

**5**

**REMO HEADS AVAILABLE**

**NEW**



Pearl White, 7" & 8 1/2"  
**RS400PW**

*Roberto Serrano*

**6**

**REMO HEADS AVAILABLE**



Vintage Black, matte, 7" & 8 1/2"  
**WB400VBK-M**

Vintage Brown, matte, 7" & 8 1/2"  
**WB400VBR-M**

Vintage Red, matte, 7" & 8 1/2"  
**WB400VR-M**

## 1 REMO® R-SERIES BONGO HEADS

**SIZES** **RHEAD-7:** 7" Macho  
**RHEAD-812:** 8 1/2" Hembra

**FIT FOR** LC300, FFB400, FWB400, CS400, WB400, BWB400, WKT400, RS400, DG400, S400

**FEATURE** For more volume and resonance

**FINISHES** **BK:** Black Calfskin Skyndeeep®; **NS:** Nuskyn®; **NT:** Fiberskyn®

## 2 LUIS CONTE SIGNATURE BONGOS

**SIZES** 6 3/4" Macho & 8" Hembra

**MATERIALS** Siam Oak (*Hevea brasiliensis* Muell.-Arg.)  
**LC300NT-M:** True Skin Cow Heads  
**LCR300NT-M:** REMO® Nuskyn® Heads

**FEATURES** Solid woodblock connection; Black powder coated hardware; 8 mm strong tuning lugs; 5 mm traditional TTR-Rims

**INCLUDES** Accessory pouch; L-shaped tuning key; Tune Up Oil

## SIGNATURE BONGOS

**3 4 5**

**SIZES** 7" Macho & 8 1/2" Hembra

**FEATURES** Meinl Free Ride Suspension System; 8 mm strong tuning lugs; 3 mm rounded SSR-Rims; Resonance Shaping Area

**INCLUDES** Accessory pouch; L-shaped tuning key; Tune Up Oil

## 3 DIEGO GALÉ SIGNATURE BONGOS

**MATERIALS** **DG400MS:** Premium Fiberglass  
REMO® Black Calfskin Skyndeeep® Heads  
**DGR400CW:** Chamchuri Wood  
REMO® Fiberskyn® Heads

**FEATURES** **DG400MS:** Chrome plated hardware  
**DGR400CW:** Brushed nickel hardware

## 4 WILLIAM "KACHIRO" THOMPSON SIGNATURE BONGOS

**MATERIALS** **WKT400BW:** New Zealand Pine Wood  
**WKT400ES:** Premium Fiberglass  
REMO® Black Calfskin Skyndeeep® Heads

**FEATURE** Chrome plated hardware

## 5 ROBERTO SERRANO SIGNATURE BONGO

**MATERIALS** Siam Oak (*Hevea brasiliensis* Muell.-Arg.)  
REMO® Fiberskyn® Heads

**FEATURE** Brushed nickel hardware

## WOODCRAFT & PROFESSIONAL SERIES WOOD BONGOS

**6 7 8 9**

**FEATURES** Meinl Free Ride Suspension System; Chrome plated hardware; 8 mm strong tuning lugs; Resonance Shaping Area

**INCLUDES** Accessory pouch; L-shaped tuning key; Tune Up Oil



**7**

REMO HEADS AVAILABLE

Natural, 7" & 8 1/2"  
**BWB400**

**8**

Antique Mahogany Burst, high gloss, 7" & 9"  
**WB500AMB**

Zebra Finished Ash, matte, 7" & 9"  
**WB500ZFA-M**

CHROME PLATED  
5 MM TRADITIONAL TTR RIM

**9**

REMO HEADS AVAILABLE

Natural, high gloss, 7" & 8 1/2"  
**FWB400NT**

Brown Burl, high gloss, 7" & 8 1/2"  
**FWB400BB**

**10**

REMO HEADS AVAILABLE

**NEW**  
Spectrum, 7" & 8 1/2"  
**S400PBK**

Cherry Red, high gloss, 7" & 8 1/2"  
**FWB400CR**

Gold Amber Sunburst, high gloss, 7" & 8 1/2"  
**FWB400GAB**

**11**

**MINI!**

Super Natural, matte, 3 1/2" & 4 1/4"  
**FWB100SNT-M**

**12**

REMO HEADS AVAILABLE

Black, 7" & 8 1/2"  
**FFB400BK**

TRUE SKIN  
COW HEADS

Black, 7" & 8 1/2"  
**FFBR400BK**

REMO® BLACK  
CALFSKIN  
SKYNDIEP® HEADS

**PREMIUM FIBERGLASS**

**6 WOODCRAFT SERIES  
WB400 WOOD BONGOS**  
SIZES 7" Macho & 8 1/2" Hembra  
MATERIALS American White Ash (*Fraxinus americana* L.)  
True Skin Cow Heads  
FEATURE 3 mm rounded SSR-Rims

**7 WOODCRAFT SERIES  
BWB400 WOOD BONGO**  
SIZES 7" Macho & 8 1/2" Hembra  
MATERIALS European Birch (*Betula pendula*)  
Hand selected cow heads  
FEATURES Natural finish European Birch shells;  
3 mm rounded SSR-Rims  
COLOUR Natural

**8 WOODCRAFT SERIES  
WB500 WOOD BONGOS**  
SIZES 7" Macho & 9" Hembra

MATERIALS American White Ash (*Fraxinus americana* L.)  
True Skin Cow Heads  
FEATURE 5 mm traditional TTR-Rims

**9 PROFESSIONAL SERIES WOOD BONGOS**  
SIZES 7" Macho & 8 1/2" Hembra  
MATERIALS Siam Oak (*Hevea brasiliensis* Muell.-Arg.)  
True Skin Cow Heads  
FEATURE 3 mm rounded SSR-Rims

**10 SPECTRUM SERIES BONGO**  
SIZES 7" Macho & 8 1/2" Hembra  
MATERIALS Siam Oak (*Hevea brasiliensis* Muell.-Arg.)  
True Skin Cow Heads  
FEATURES Meinl Free Ride Suspension System;  
Spectrum Series hardware; 8 mm strong tuning lugs;  
3 mm rounded SSR-Rims  
INCLUDES Accessory pouch; L-shaped tuning key; Tune Up Oil

**11 MINI WOOD BONGO**  
SIZES 3 1/2" Macho & 4 1/4" Hembra  
MATERIALS Siam Oak (*Hevea brasiliensis* Muell.-Arg.)  
True Skin Buffalo Heads  
FEATURES Meinl Free Ride Suspension System;  
2 mm rounded SSR-Rims  
INCLUDES Tuning key

**12 FIBERCRAFT SERIES FIBERGLASS BONGOS**  
SIZES 7" Macho & 8 1/2" Hembra  
MATERIALS Premium fiberglass  
**FFB400BK**: True Skin Cow Heads  
**FFBR400BK**: REMO® Black Calfskin Skyndiep® Heads  
FEATURES Meinl Free Ride Suspension System;  
Chrome plated hardware; 8 mm strong tuning lugs;  
3 mm rounded SSR-Rims; Resonance Shaping Area  
INCLUDES Accessory pouch; L-shaped tuning key; Tune Up Oil

# BONGOS

1



Black, 6 1/2" & 7 1/2"  
**HB50BK**



Ultimate Grey, 6 1/2" & 7 1/2"  
**HB50UG**



Bright White, 6 1/2" & 7 1/2"  
**HB50WH**



Flamingo Pink, 6 1/2" & 7 1/2"  
**HB50FP**



Red, 6 1/2" & 7 1/2"  
**HB50R**



Electric Coral, 6 1/2" & 7 1/2"  
**HB50EC**



Creamsicle, 6 1/2" & 7 1/2"  
**HB50CS**



Illuminating Yellow, 6 1/2" & 7 1/2"  
**HB50IY**



Forest Green, 6 1/2" & 7 1/2"  
**HB50FG**



Seafoam Green, 6 1/2" & 7 1/2"  
**HB50SF**



Glacier Blue, 6 1/2" & 7 1/2"  
**HB50GB**

2



Walnut Brown, 6 3/4" & 8"  
**HTB100WB-M**

TRADITIONAL  
TTR-RIM

3



Natural, 6 3/4" & 8"  
**HB100NT**



Vintage Sunburst, 6 3/4" & 8"  
**HB100VSB**



Wine Red Burst, 6 3/4" & 8"  
**HB100WRB**



Vintage Wine Barrel, 6 3/4" & 8"  
**HB100VWB-M**

## 1 JOURNEY SERIES HB50 BONGOS

**SIZES** 6 1/2" Macho & 7 1/2" Hembra  
**MATERIALS** Molded ABS  
Hand selected buffalo heads  
**FEATURES** Black powder coated hardware;  
Rounded rims for playing comfort  
**INCLUDES** Tuning key  
**COLOURS** **BK:** Black; **CS:** Creamsicle; **EC:** Electric  
Coral; **FG:** Forest Green; **FP:** Flamingo  
Pink; **GB:** Glacier Blue; **IY:** Illuminating  
Yellow; **R:** Red; **SF:** Seafoam Green;  
**UG:** Ultimate Grey; **WH:** Bright White

## HEADLINER® SERIES WOOD BONGOS

**2 3**  
**SIZES** 6 3/4" Macho & 8" Hembra  
**MATERIALS** Siam Oak (*Hevea brasiliensis* Muell.-Arg.)  
Hand selected buffalo heads  
**FEATURES** Black powder coated hardware; 8 mm  
strong tuning lugs; Interior backing plates

**INCLUDES** Tuning key

## 2 HEADLINER® SERIES HTB100 WOOD BONGO

**FEATURE** 5 mm strong TTR-Rims  
**COLOUR** **WB-M:** Walnut Brown, matte

## 3 HEADLINER® SERIES HB100 WOOD BONGOS

**FEATURE** 2 mm rounded rims for playing comfort  
**COLOURS** **NT:** Natural, high gloss  
**VSB:** Vintage Sunburst, high gloss  
**VWB-M:** Vintage Wine Barrel, matte  
**WRB:** Wine Red Burst, high gloss

## 4 BONGO & PERCUSSION PACK

**CONTAINS** Journey Series HB50BK Bongo; Compact  
Foot Tambourine; Luis Conte Live Shaker;  
Classic Wood Claves

## 5 HEADLINER® SERIES HFB100 FIBERGLASS BONGO

**SIZES** 6 3/4" Macho & 8" Hembra  
**MATERIALS** Premium fiberglass  
Hand selected buffalo heads  
**FEATURES** Black powder coated hardware; 8 mm  
strong tuning lugs; 2.6 mm rounded rims  
**INCLUDES** Tuning key  
**COLOUR** **BK:** Black

## 6 WB200 WOOD BONGOS

**SIZES** 6 3/4" Macho & 8" Hembra  
**MATERIALS** Siam Oak (*Hevea brasiliensis* Muell.-Arg.)  
Hand selected buffalo heads  
**FEATURES** Solid woodblock connection; 8 mm strong  
tuning lugs; 2 mm rounded SSR-Rims  
**WB200NT-CH:** Chrome plated hardware  
**WB200NT-G:** Gold tone hardware  
**WB200SNT-M:** Chrome plated hardware





**BONGOS**

**4**

Set, 4 pcs.  
**BPP-1**

**WITH JOURNEY SERIES HB50BK BONGO**

**5**

Black, 6 3/4" & 8"  
**HFB100BK**

**PREMIUM FIBERGLASS**

**6**

Natural, 6 3/4" & 8"  
**WB200NT-CH**

**CHROME PLATED ROUNDED SSR RIM**

**7**

**NEW**  
REMO HEADS AVAILABLE

Wine Red, 6 3/4" & 8"  
**WBTR300WR**

**TRADITIONAL TTR-RIM**

**7**

Natural, 6 3/4" & 8"  
**WB200NT-G**

**GOLD TONE ROUNDED SSR RIM**

**7**

Super Natural, 6 3/4" & 8"  
**WB200SNT-M**

**CHROME PLATED ROUNDED SSR RIM**

**8**

Natural, 6 3/4" & 8"  
**FWB200NT**

Gold Amber Sunburst, 6 3/4" & 8"  
**FWB200GAB**

**9**

Leopard Burl, 6 3/4" & 8"  
**FWB190LB**

Amber Flame, 6 3/4" & 8"  
**FWB190AF**

**10**

Natural, 6 3/4" & 8"  
**FWB190NT**

Super Natural, 6 3/4" & 8"  
**FWB190SNT-M**

Antique Tobacco Burst, 6 3/4" & 8"  
**FWB190ATB-M**

**11**

**NEW**

Wine Red, 6 3/4" & 8"  
**WB200WRP-CH**

**INCLUDES** Accessory pouch; L-shaped tuning key; Tune Up Oil  
**COLOURS** **NT:** Natural, high gloss  
**SNT-M:** Super Natural, matte

**7 TRADITIONAL SERIES BONGO**  
**SIZES** 6 3/4" Macho & 8" Hembra  
**MATERIALS** Siam Oak (*Hevea brasiliensis* Muell.-Arg.)  
 REMO® Black Calfskin Skyndee® Heads  
**FEATURES** Solid woodblock connection; Black powder coated hardware; 8 mm strong tuning lugs; 5 mm traditional TTR-Rims  
**INCLUDES** Accessory pouch; L-shaped tuning key; Tune Up Oil  
**COLOUR** **WR:** Wine Red, high gloss

**MARATHON® SERIES FWB WOOD BONGOS**  
**8 9 10**  
**SIZES** 6 3/4" Macho & 8" Hembra

**MATERIALS** Siam Oak (*Hevea brasiliensis* Muell.-Arg.)  
 Hand selected buffalo heads  
**FEATURES** Meinl Free Ride Suspension System; 8 mm strong tuning lugs  
**INCLUDES** Accessory pouch; L-shaped tuning key; Tune Up Oil

**8 MARATHON® EXCLUSIVE SERIES FWB200 WOOD BONGOS**  
**FEATURES** Chrome plated hardware; 2 mm rounded SSR-Rims  
**COLOURS** **GAB:** Gold Amber Sunburst, high gloss  
**NT:** Natural, high gloss

**9 MARATHON® DESIGNER SERIES FWB190 WOOD BONGOS**  
**FEATURES** Unique designs; Black powder coated hardware; 2.5 mm rounded SSR-Rims  
**COLOURS** **AF:** Amber Flame, high gloss  
**LB:** Leopard Burl, high gloss

**10 MARATHON® SERIES FWB190 WOOD BONGOS**  
**FEATURES** Black powder coated hardware; 2 mm rounded SSR-Rims  
**COLOURS** **ATB-M:** Antique Tobacco Burst, matte  
**NT:** Natural, high gloss  
**SNT-M:** Super Natural, matte

**11 MARATHON® EXCLUSIVE SERIES WB200 WOOD BONGO**  
**SIZES** 6 3/4" Macho & 8" Hembra  
**MATERIALS** New Zealand Pine Wood  
 Hand selected buffalo heads  
**FEATURES** Solid woodblock connection; Chrome plated hardware  
**INCLUDES** Accessory pouch; L-shaped tuning key; Tune Up Oil  
**COLOUR** **WR:** Wine Red, high gloss

# TIMBALES



The Timbales originated in the center of the Caribbean, where life's rhythms pulsate through the atmosphere like a constant heartbeat. These drums were originally played in small, private gatherings, and they have resonant tones and sleek, attractive shells. Their influence in the music industry increased along with the boldness of their rhythms. The Timbales are still going strong today, incorporating new genres into their sound as it develops.

Meinl Timbales are as inventive and one-of-a-kind as the artists that contributed to their creation. We collaborate closely with the best timbaleros in the world on a daily basis. By doing this, these timbales continue to serve as a symbol of lively tradition and inventive music, testifying to the rich cultural legacy of the Caribbean.

# SIGNATURE TIMBALES & HAND-BALE



TIMBALES

**1** **NEW**

*Manolito Rodriguez*

Atomic Red,  
14" & 15"  
**MR1415**

**2** **NEW**

*Diego Camacho*

Black Diamond,  
14" & 15"  
**DC1415**



**3**

*Amadito Valdés*

Antique bronze,  
14" & 15"  
**AV1ABR**

**4**

*Diego Galé*

Solid brass,  
14" & 15"  
**DG1415**

**5**

*Luis Conte*

Solid brass,  
14" & 15"  
**LC1BRASS**

Stainless steel,  
14" & 15"  
**LC1STS**

**6** **SPECIAL DESIGNED RIM**

*Taku Hirano*

Black powder coated steel, 13"  
**MHT13BK**

## SIGNATURE TIMBALES

**1 2 3 4 5**

**SIZES** 14" & 15"

**INCLUDES** L-shaped tuning key; Tune Up Oil

### 1 MANOLITO RODRIGUEZ SIGNATURE TIMBALES

**MATERIALS** Steel

Black synthetic heads

**FEATURES** Black nickel hardware; Easy-Tuning System

**INCLUDES** Professional Timbale Stand

**FINISH** Atomic Red

### 2 DIEGO CAMACHO SIGNATURE TIMBALES

**MATERIALS** Steel

Black synthetic heads

**FEATURES** Black nickel hardware; Easy-Tuning System

**INCLUDES** Professional Timbale Stand

**FINISH** Black Diamond

## 3 AMADITO VALDÉS SIGNATURE TIMBALES

**MATERIAL** Steel

**FEATURES** Two worked-in flanges; Floatune Tuning System; Logo applied from underneath the head (CN, TH, US patent)

**INCLUDES** Height adjustable tilting double braced tripod stand; Adjustable cowbell holder; Accessory pouch

**COLOUR** Antique bronze

## 4 DIEGO GALÉ SIGNATURE TIMBALES

**MATERIAL** Solid brass

**FEATURES** Classic Timbales shape and look; Logo applied from underneath the head (CN, TH, US patent)

**INCLUDES** Professional Timbale Stand; Adjustable cowbell holder; Accessory pouch

## 5 LUIS CONTE SIGNATURE TIMBALES

**MATERIALS** **LC1BRASS:** Solid brass

**LC1STS:** Stainless steel

**FEATURES** Two worked-in flanges; Cuban style flared out bottom edge; Logo applied from underneath the head (CN, TH, US patent)

**INCLUDES** Height adjustable tilting double braced tripod stand; Adjustable cowbell holder; Accessory pouch

## 6 TAKU HIRANO SIGNATURE HAND-BALE

**SIZE** 13"

**MATERIAL** Black powder coated steel

**FEATURE** Logo applied from underneath the head (CN, TH, US patent)

**INCLUDES** L-shaped tuning key; Tune Up Oil

**COLOUR** **BK:** Black, high gloss

# TIMBALES HEADS & TIMBALES

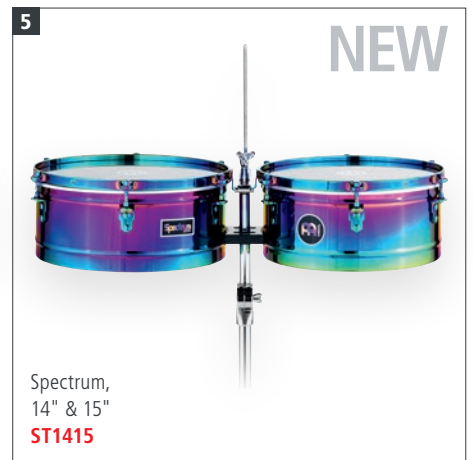
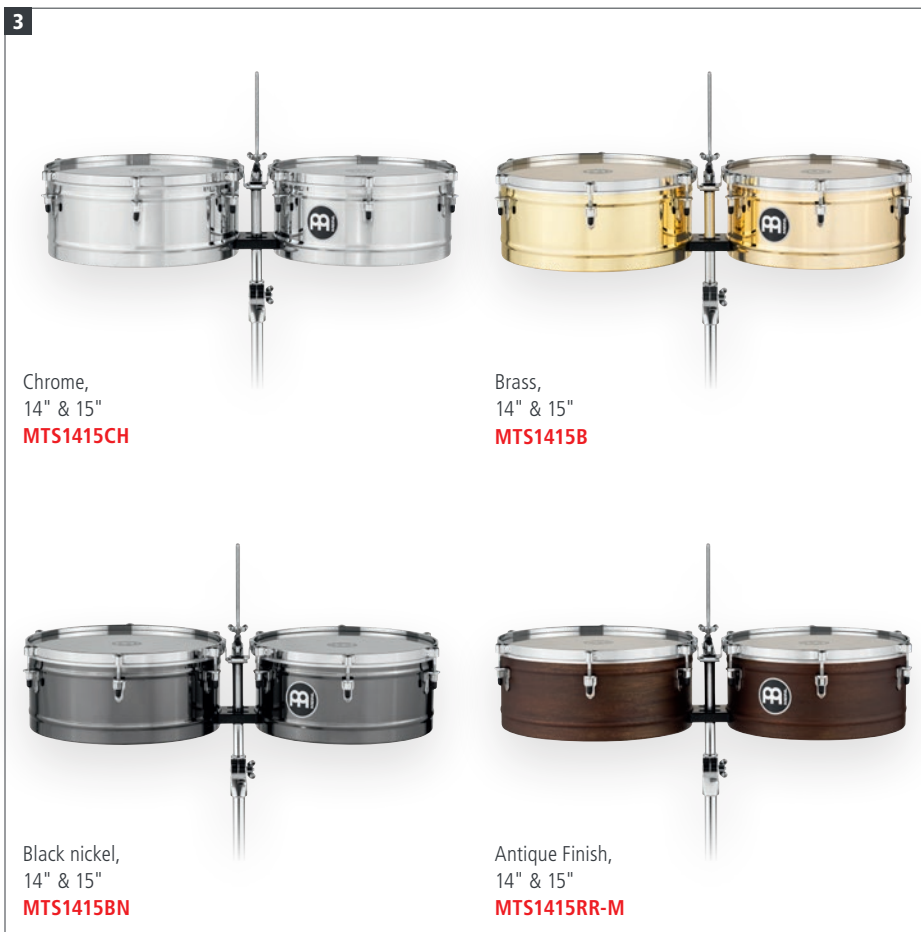
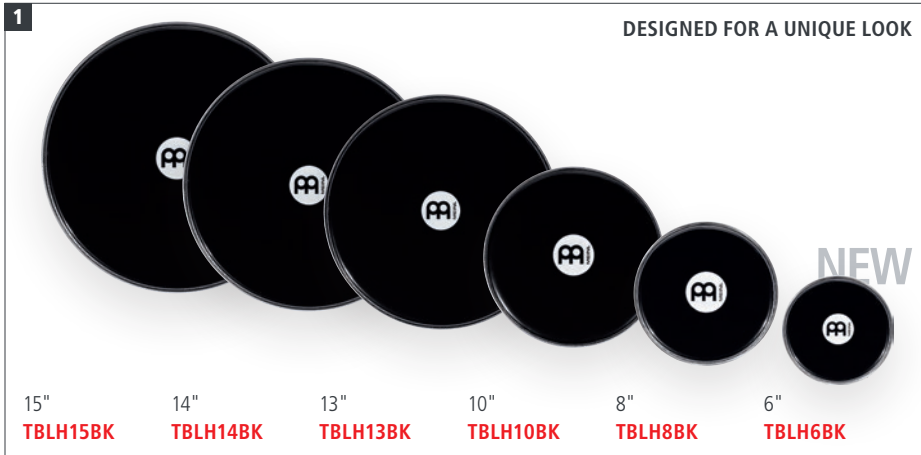

## 1 TIMBALES HEADS

**SIZES** **TBLH6BK:** 6"  
**TBLH8BK:** 8" (Mini Timbales Head)  
**TBLH10BK:** 10" (Mini Timbales Head)  
**TBLH13BK:** 13"  
**TBLH14BK:** 14"  
**TBLH15BK:** 15"

**MATERIAL** Synthetic head

**FEATURES** Cutting and clean tone with effortless response; Extremely durable

**COLOUR** Black

## 2 HEADLINER® SERIES TIMBALES

**SIZES** 13" & 14"

**MATERIAL** Steel

**FEATURES** Logo applied from underneath the head (CN, TH, US patent); Two worked-in flanges

**INCLUDES** Height adjustable tilting double braced tripod stand; Tuning key; Wrench; Cowbell holder

**FINISH** Chrome

## 3 MARATHON® SERIES TIMBALES

**SIZES** 14" & 15", 6.5" deep

**MATERIAL** Steel

**FEATURES** Two worked-in flanges; Heavy-duty style brackets; Logo applied from underneath the head (CN, TH, US patent)

**INCLUDES** Adjustable cowbell holder; Height adjustable tilting double braced tripod stand; Accessory pouch; L-shaped tuning key; Tune Up Oil

**FINISHES** **B:** Brass  
**BN:** Black nickel  
**CH:** Chrome  
**RR-M:** Antique Finish, matte

## 4 MARATHON® SERIES TURBO TIMBALES

**SIZES** 14" & 15", 10" deep

**MATERIAL** Black powder coated steel

**FEATURES** Three worked-in flanges; Heavy-duty style brackets; Logo applied from underneath the head (CN, TH, US patent)

**INCLUDES** Adjustable cowbell holder; Height adjustable tilting double braced tripod stand; Accessory pouch; L-shaped tuning key; Tune Up Oil

**COLOUR** **BK:** Black

## 5 SPECTRUM SERIES TIMBALES

**SIZES** 14" & 15"

**MATERIALS** Steel

**FEATURES** Spectrum Series hardware; Easy-Tuning System

**INCLUDES** Professional Timbale Stand; L-shaped tuning key; Tune Up Oil

**FINISH** Spectrum

# DRUMMER TIMBALES & COMPACT SNARE DRUMS



**6**

**NEW**

SNARE WIRES ARE ABSOLUTELY QUIET AND CHATTER-FREE IN THE "OFF" POSITION





Black powder coated steel, 6"  
**MDST6BK**

Black powder coated steel, 8"  
**MDST8BK**

Black powder coated steel, 10"  
**MDST10BK**

**7**

**NEW**



Spectrum, 6"  
**SMDT6**

**8**

**NEW**



Spectrum, 6" & 8"  
**SMIT68**



Spectrum, 8" & 10"  
**SMIT810**

**9**



Chrome, 8" & 10"  
**MIT810CH**



Chrome, 13"  
**MDT13CH**

**10**



Maple, 10"  
**MPCSS**

**11**



Maple, 10"  
**MPJS**

**6 DRUMMER SNARE TIMBALES**

**SIZES** **MDST6:** 6"  
**MDST8:** 8"  
**MDST10:** 10"

**MATERIALS** Black powder coated steel

**FEATURES** **MDST6BK:** Black timbales head  
**MDST6BK**  
Top-Tuning System; Quick snare on/off system  
**MDST8BK, MDST10BK**  
Quick snare on/off system; Chatter-free "off" position; Logo applied from underneath the head (CN, TH, US patent)

**INCLUDES** **MDST6BK:** Drum Key  
**MDST8BK, MDST10BK:** L-shaped tuning key; Tune Up Oil

**COLOUR** **BK:** Black

**7 SPECTRUM SERIES DRUMMER SNARE TIMBALES**

**SIZE** 6"

**MATERIALS** Steel

**FEATURES** Top-Tuning System; Quick snare on/off system; Chrome hardware

**INCLUDES** Drum Key

**FINISH** Spectrum

**8 SPECTRUM SERIES DRUMMER MINI TIMBALES**

**SIZES** **SMIT68:** 6" & 8"  
**SMIT810:** 8" & 10"

**MATERIALS** Steel

**FEATURES** Black timbales heads

**INCLUDES** Chrome hardware

**FINISH** L-shaped tuning key; Tune Up Oil  
Spectrum

**9 DRUMMER TIMBALE & MINI TIMBALES**

**SIZES** **MDT13CH:** 13" (Drummer Timbale)  
**MIT810CH:** 8" & 10" (Mini Timbales)

**MATERIAL** Steel

**FEATURE** Logo applied from underneath the head (CN, TH, US patent)

**INCLUDES** L-shaped tuning key; Tune Up Oil

**10 COMPACT SIDE SNARE DRUM**

**SIZE** 10", 3.5" deep

**MATERIAL** Maple

**COLOUR** Black

**11 COMPACT JINGLE SNARE DRUM**

**SIZE** 10", 4.5" deep

**MATERIALS** Maple shell

**COLOUR** Stainless steel jingles  
Black

TIMBALES

# COWBELLS



The cowbell, a versatile and distinctive percussion instrument, carries a rich and fascinating history. Born as a humble bell for livestock, it transcended its origins to become a vital part of musical traditions around the world. Its true essence shines most brightly in the passionate rhythms of Latin percussion. Played with a wooden stick, the cowbell anchors the rhythm section and keeps the group in sync.

Meinl offers a wide range of cowbells in various sizes and tunings, each crafted to produce unique and expressive sounds. We collaborate closely with our artists to fulfill their every need, ensuring that every player finds the perfect rhythm and tone. Whether it's the sharp accent in a rock beat or the heartbeat of a Latin ensemble, Meinl's cowbells bring passion and precision to every performance.

# SIGNATURE COWBELLS



8"  
DG-RTB

5"  
DG-RCCB



8"  
MR-AMB



GROOVE BELL DESIGNED  
WITH MIKE JOHNSTON

7 3/4"  
MJ-GB



4 1/2"  
AN-BB

## 1 DIEGO GALÉ SIGNATURE ROYAL COWBELLS

**SIZES** DG-RTB: 8" (Timbale Cowbell)  
DG-RCCB: 5" (Cha Cha Cowbell)  
**MATERIAL** Special steel alloy  
**FEATURES** Designed with Diego Galé  
DG-RTB: Deep pitch and dry overtones  
DG-RCCB: High pitched and bright sound  
**FINISH** Royal Gold

## 2 MANOLITO RODRIGUEZ SIGNATURE ANTIQUE MAMBO COWBELL

**SIZE** 8" (Mambo Cowbell)  
**MATERIAL** Special steel alloy  
**FEATURES** Designed with Manolito Rodriguez  
Deep pitch and dry overtones  
**FINISH** Antique

## 3 ANIKA NILLES SIGNATURE COWBELL, BEAT BELL

**SIZE** 4 1/2"  
**MATERIAL** Special steel alloy  
**FEATURES** Attaches directly to your snare  
No stand required  
**INCLUDES** Rim clamp; U-shaped rod; Drum Honey; Drum key

## 4 MIKE JOHNSTON SIGNATURE COWBELL, GROOVE BELL

**SIZE** 7 3/4"  
**MATERIAL** Special steel alloy  
**FEATURE** Specifically made for drum set use  
**INCLUDES** Two magnets (one small and one large, based on Benny Greb's Magnetic Sustain Control idea)  
**FINISH** Vintage Steel

## PERCUSSION BLOCKS (SEE PAGE 36)



MPE5NG

MPE3BK

MPE4R

COWBELLS

# COWBELLS

**1** BLACK POWDER COATED STEEL



8" **HCO2BK**      5" **HCO4BK**

**2** BLACK POWDER COATED STEEL



8 1/2" **SL850-BK**      6 3/4" **SL675-BK**      5 1/4" **SL525-BK**      4 3/4" **SL475-BK**

**3** EASY MOUNTABLE



2 1/2", 3 1/2", 5" **SLTRI-BK**

**4** CLASSIC ROCK COWBELL      TIMBALERO COWBELLS



7" big mouth, low pitch **SCL70B-BK**      8 1/2" low pitch **SCL850-BK**      7" high pitch **SCL70-BK**

**5** HIGH POLISHED CHROME



8" big mouth **STB80B-CH**      8" small mouth **STB80S-CH**      7 1/2" **STB750-CH**      6 1/4" **STB625-CH**      5 1/2" **STB55-CH**      4 1/2" low pitch **STB45L-CH**

**5** HAND BRUSHED STEEL



8" big mouth **STB80B**      8" small mouth **STB80S**      6 1/4" **STB625**      5 1/2" **STB55**      4 1/2" low pitch **STB45L**      4 1/2" medium pitch **STB45M**      4 1/2" high pitch **STB45H**

## COWBELLS 1 – 10

MATERIAL Special steel alloy

### 1 HEADLINER® SERIES COWBELLS

SIZES **HCO2BK**: 8" (Timbales Cowbell)  
**HCO4BK**: 5" (Cha Cha Cowbell)

FEATURE Muffled sound  
FINISH **BK**: Black powder coated

### 2 BLACK FINISH COWBELLS

SIZES **SL850-BK**: 8 1/2" (Timbales Cowbell)  
**SL675-BK**: 6 3/4" (Medium Timbales Cowbell)  
**SL525-BK**: 5 1/4" (Cha Cha Cowbell)  
**SL475-BK**: 4 3/4" (Mini Cha Cha Cowbell)

FEATURE Muffled sound  
FINISH **BK**: Black powder coated

### 3 TRIPLE BELL

SIZES 2 1/2", 3 1/2", 5"

FEATURE Muffled sound  
FINISH **BK**: Black powder coated

### 4 STEEL CRAFT LINE COWBELLS

SIZES **SCL70B-BK**: 7" (Classic Rock Cowbell Big Mouth)  
**SCL850-BK**: 8 1/2" (Timbalero Cowbell)  
**SCL70-BK**: 7" (Timbalero Cowbell)

FEATURES Steel alloy controls overtones and resonance; Classic cowbell sound for any setting  
FINISH **BK**: Black powder coated

### 5 CHROME & STEEL FINISH COWBELLS



SIZES **STB80B**: 8" (Timbales Cowbell Big Mouth)  
**STB80S**: 8" (Timbales Cowbell Small Mouth)  
**STB750**: 7 1/2" (Salsa Timbales Cowbell)  
**STB625**: 6 1/4" (Medium Timbales Cowbell)  
**STB55**: 5 1/2" (Cha Cha Cowbell)  
**STB45L**: 4 1/2" (Low Cha Cha Cowbell)  
**STB45M**: 4 1/2" (Medium Cha Cha Cowbell)  
**STB45H**: 4 1/2" (High Cha Cha Cowbell)

FEATURE Tonally matched  
FINISHES **CH**: High polished chrome



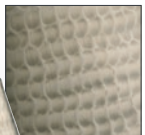

**6** **HAND BRUSHED GOLD**    
8" big mouth **STB80BHH-G**    6 1/4" **STB625HH-G**

**HAND BRUSHED STEEL**    
8" big mouth **STB80BHH-S**    6 1/4" **STB625HH-S**

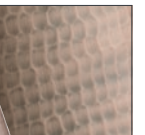
**HAND BRUSHED COPPER**    
8" big mouth **STB80BHH-C**    6 1/4" **STB625HH-C**

**7** **NEW**  **NEW**   
8 1/2" **SHBC**    7 1/2" **SHBG**

**8** **BLACK POWDER COATED STEEL**   
8" **BCOB**

**9** **SPECIAL STEEL ALLOY**     
8 1/4" **STB815H**    7 3/4" **STB785H**    6 1/2" **STB65H**

**10** **COMFORTABLE HOLDER**    
6 1/4" **STB625HA-CB**    4 1/2" **STB45HA-CB**

**8** **PALO COWBELL BEATER**  
(SEE PAGE 125)  
  
**COW5**

**11**   
Magnetic Sustain Control  
**MCT**  
BASED ON BENNY GREB'S IDEA

**12**   
Drum Honey Slab  
**MDHS**

**13** **A DROP OF HONEY MAKES YOUR DRUMS AND CYMBALS SOUND SWEET**  
  
Drum Honey **MDH**    Drum Honey Assortment **MDHA**

**14**   
Medium **MPCC-M**    Large **MPCC-L**

**6 HAMMERED COWBELLS**  
SIZES **STB80BHH:** 8" (Timbales Cowbell Big Mouth)  
**STB625HH:** 6 1/4" (Medium Timbales Cowbell)  
FEATURE Hammered  
FINISHES **C:** Hand brushed copper  
**G:** Hand brushed gold  
**S:** Hand brushed steel

**7 SALSA HANDHELD COWBELLS**  
SIZES **SHBC:** 8 1/2"  
**SHBG:** 7 1/2"  
TUNING **SHBC:** C  
**SHBG:** G

**8 BONGO COWBELL**  
SIZE 8" (Medium Handheld Cowbell)  
FEATURES Muffled sound; For low volume playing  
FINISH Black powder coated

**9 HAND COWBELLS**  
SIZES **STB815H:** 8 1/4" (High Handheld Cowbell)  
**STB785H:** 7 3/4" (Low Handheld Cowbell)  
**STB65H:** 6 1/2" (Mini Handheld Cowbell)  
FINISH Hand brushed steel

**10 HANDHELD COWBELLS**  
SIZES **STB625HA-CB:** 6 1/4"  
**STB45HA-CB:** 4 1/2"  
FEATURE Comfortable holder  
FINISH Hand brushed steel

**11 MAGNETIC SUSTAIN CONTROL**  
CONTAINS 2 x Light dampening magnets (16 x 4 mm)  
2 x Heavy dampening magnets (16 x 9 mm)  
FEATURE Easily control the sustain and dampen the tone of your cymbals or cowbells  
INCLUDES Storage container

**12 DRUM HONEY SLAB**  
SIZE 3.54" x 2.36" x 0.31"  
FEATURES Extra thick rectangular dampening gel pad; Creates a super meaty drum tone

**13 DRUM HONEY**  
CONTAINS **MDH:** 1 pack of Drum Honey (6 pcs.)  
**MDHA:** 12-piece Drum Honey Assortment (6 x small, 4 x medium, 2 x large)  
FEATURES Transforms your drum sound into a warm and sweet tone with no effort; The gels can be removed and reused as needed; Washable and non-toxic

**14 COWBELL CUSHIONS**  
SIZES **MPCC-M:** Medium (32 grams)  
**MPCC-L:** Large (70 grams)  
FEATURES Instantly turn your cowbell sound into a retro, super-dry effect; No adhesive material required



PARCERO

SNAPBACK

PARCERO

PARCERO

PARCERO

# LATIN INSTRUMENTS



Discover the vibrant world of Latin hand percussion instruments, where rhythm and culture come together. Our collection features a variety of traditional instruments like maracas, güiros, claves, cabasas and many more, perfect for adding authentic Latin flavor to your music. Whether you're a professional musician or a hobbyist, these instruments bring warmth, energy, and versatility to any performance. Explore the craftsmanship and history behind each piece, and elevate your sound with the rich percussive beats of Latin America.

# GÜIROS & CLAVES



**1 TURBO GÜIRO**  
MATERIAL High strength plastic  
FEATURES Three striking surfaces;  
Rubber ringed grip holes  
INCLUDES Synthetic scraper

**2 FIBERGLASS GÜIROS**  
MATERIAL Premium fiberglass  
FEATURES Three striking surfaces; Padded grip holes  
INCLUDES **GU7BK**: Synthetic scraper  
**GU7BR**: Wooden scraper  
COLOURS **BK**: Black  
**BR**: Brown

**3 WOOD GÜIRO**  
MATERIAL Wood  
FEATURE Grip holes  
INCLUDES Wooden scraper  
COLOUR **AM**: Amber

**4 LATIN RHYTHM CLAVES**  
SIZE 8" & 7" long  
MATERIAL Select Hardwood  
FEATURES For foundational latin rhythms;  
Solid body construction; Traditional look

**5 WOOD CLAVES, CLASSIC**  
MATERIALS **HW**: Hardwood  
**RW**: Select Hardwood  
FEATURE Solid body

**6 WOOD CLAVES, AFRICAN**  
MATERIALS **HW**: Hardwood  
**RW**: Select Hardwood  
FEATURES **CL2**: Solid body  
**CL3**: Hollowed out body

**7 WOOD CLAVES, TRADITIONAL**  
SIZE 8" long and 1" diameter  
MATERIAL **IW**: Indian Walnut  
FEATURE Classic pitch and clear, piercing attack

**8 CLAVES DE LUXE**  
SIZE 6 3/4" long  
MATERIAL Dense hardwood  
FEATURES Cutting sound; Convenient carrying

# MARACAS



## 1 RAWHIDE MARACAS

- SIZES** **MSM2:** Mini  
**MSM3:** Traditional  
**MSM4:** Jumbo
- MATERIALS** Natural rawhide and wooden handle
- FEATURES** Entirely made by hand  
Offers a wide sonic range  
Durable construction
- DESIGNS** **CO:** Colombia flag  
**CU:** Cuba flag  
**MX:** Mexico flag

## 2 WOOD MARACAS

- MATERIAL** Wood
- FEATURES** Produces a traditional warm and rich sound  
Available in both round and oval models

## 3 PLASTIC EGG MARACAS

- SIZE** 6"
- MATERIAL** Synthetic
- FEATURE** Ergonomically shaped handle

## 4 CONCERT, SESSION, STUDIO & LIVE MARACAS

- MATERIAL** Synthetic heads
- FEATURE** Ergonomically shaped handle
- COLOURS** **BG:** Beige  
**BK:** Black



# LATIN INSTRUMENTS



Set, 5 pcs.  
**TMSTB**



High pitch  
**MPE5NG**

Medium pitch  
**MPE3BK**

Low pitch  
**MPE4R**



Set, 5 pcs.  
**TMWTB**



**TMWB-XS**

**TMWB-S**

**TMWB-L**



**MWBHC**



Large  
**PMWB1-L**

Medium  
**PMWB1-M**



Medium  
**MWB1BK**

Large  
**MWB2BK**

## 1 SYNTHETIC TEMPLE BLOCK SET

**MATERIAL** PE  
**FEATURES** 5-piece set of durable synthetic percussion blocks; Varying pitch from high (smallest block) to low (largest block); Metal frame with adjustable thumb screw mount  
**INCLUDES** Mounting Clamp; Beater  
**COLOUR** Black

## 2 PERCUSSION BLOCKS

**MATERIAL** PE  
**FEATURES** Ultra-durable plastic  
**MPE5NG**: High pitched sound  
**MPE3BK**: Medium pitched sound  
**MPE4R**: Low pitched sound  
**INCLUDES** Mounting Clamp  
**COLOURS** **BK**: Black  
**NG**: Neon Green  
**R**: Red

## 3 WOOD TEMPLE BLOCK SET

**MATERIAL** Baltic Birch (*Betula pendula*)  
**FEATURES** 5-piece tonally matched wood temple block set; 100% Baltic birch construction for natural wood tone; Rear mount fits any standard drum hardware; Tuning from low to high: D5, F5, A5, C6, D6  
**INCLUDES** Two soft rubber head mallets

## 4 WOOD TEMPLE BLOCKS

**MATERIAL** Baltic Birch (*Betula pendula*)  
**TUNING** **TMWB-XS**: D6  
**TMWB-S**: C6  
**TMWB-L**: F5  
**FEATURES** Natural wood tone; Fits a variety of musical situations  
**INCLUDES** Wood block holder

## 5 WOOD BLOCK HAND CLAP

**MATERIAL** Baltic Birch (*Betula pendula*)

**FEATURES** Combination wood block and hand clap effect; Padded surface to play with drumsticks

## 6 PROFESSIONAL WOOD BLOCKS

**SIZES** **M**: Medium  
**L**: Large  
**MATERIALS** Select Hardwood top  
Siam Oak body  
(*Hevea brasiliensis* Muell.-Arg.)  
**FEATURE** Well defined fundamental sound  
**INCLUDES** Wooden beater

## 7 WOOD BLOCKS

**SIZES** **MWB1BK**: Medium  
**MWB2BK**: Large  
**MATERIAL** Siam Oak (*Hevea brasiliensis* Muell.-Arg.)  
**FEATURE** Rounded playing surface  
**INCLUDES** Wooden beater  
**COLOUR** **BK**: Black, matte

**8** PORTS FOR MORE VOLUME (PATENTED)

X-Small  
**PCA5BK-XS**

Small  
**CA5BK-S**

Medium  
**CA5BK**

Large  
**CA5BK-L**

**9** ADJUSTABLE NET FOR VARIOUS TENSIONS AND SOUND OPTIONS

**CA7BR**

**10**

**SH-R**      **SHR-BR**      **SHK**

NEARLY UNBREAKABLE

**11**

**RO3BK**

**12** TRUE SKIN BUFFALO HEADS

11"  
**MTA1SNT-M**

**13** HEAVY-DUTY STAND CAN BE TILTED

8" & 9"  
**HCG89NT**

**14**

X-Small  
**MGU4**

Small  
**MGU3**

Large  
**MGU1**

COMES WITH SCRAPER

**15**

**MGU51**

8" & 9"  
**HCG89NT**

**8 TURBO CABASAS (PATENTED)**  
**SIZES** **PCA5BK-XS**: X-Small; **CA5BK-S**: Small  
**CA5BK**: Medium; **CA5BK-L**: Large  
**MATERIALS** Steel chain and stainless steel cylinder  
**CA**: Wooden handle with padded soft grip  
**PCA**: Synthetic grip  
**FEATURE** 5 sound ports on each side for more volume (CN, US patent)  
**COLOUR** **BK**: Black

**9 CABASA, FIBERGLASS**  
**MATERIAL** Premium fiberglass  
**FEATURES** Adjustable net for various tensions and sound options; Equals a traditional gourd calabash  
**COLOUR** **BR**: Brown

**10 SHEKERES**  
**SIZES** **SH-R, SHR-BR**: Medium  
**SHK**: Traditional

**MATERIALS** **SH-R, SHR-BR**: Premium fiberglass  
**SHK**: Gourd  
**COLOURS** **BR**: Brown  
**R**: Red

**11 THE ROAR**  
**MATERIAL** Wood  
**FEATURE** Rattling sustain

**12 TAMBORA**  
**SIZE** 11"  
**MATERIALS** Siam Oak (*Hevea brasiliensis* Muell.-Arg.)  
True Skin Buffalo Heads  
**FEATURE** Black powder coated hardware  
**INCLUDES** Nylon strap; Wooden beaters; Tuning key  
**COLOUR** **SNT-M**: Super Natural  
**FINISH** Matte

**13 WOOD CONGUITAS**  
**SIZES** 8" & 9"

**MATERIALS** Siam Oak (*Hevea brasiliensis* Muell.-Arg.)  
Hand selected buffalo heads  
**INCLUDES** Height adjustable tilting double braced tripod stand; Tuning key; Wrench  
**COLOUR** **NT**: Natural  
**FINISH** High gloss

**14 MERENGUE GÜIRAS**  
**SIZES** **MGU4**: X-Small; **MGU3**: Small;  
**MGU1**: Large  
**MATERIAL** Brushed steel  
**FEATURE** One-piece metal grip with welded flanges  
**INCLUDES** ABS scraper MG52

**15 MERENGUE GÜIRA SHAKER**  
**MATERIAL** Brushed steel  
**FEATURE** Filling inside to produce a cutting shaker effect  
**INCLUDES** ABS scraper MG52

# CAJONS



The cajón is a versatile and dynamic percussion instrument, rooted in Afro-Peruvian traditions and widely used across various music genres. Its simple wooden box design delivers deep bass tones and sharp, snappy highs, making it perfect for both acoustic and amplified performances. Whether you're playing flamenco, Latin, or contemporary music, the cajón offers a rich rhythmic foundation. Ideal for drummers and percussionists alike, its portability and range of sounds make it an essential addition to any setup. Explore the rhythmic possibilities of the cajón and bring a new dimension to your music.





# ARTISAN EDITION CAJONS

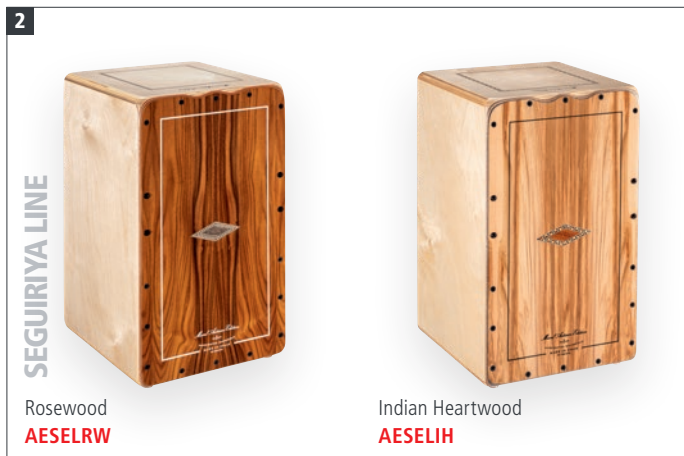

**José Hernández Díaz** also known as 'Pepote' – was born in Huelva (Spain) in November 1976. He inherited his passion for wood from his father and grandfather, both of whom were aficionados of woodworking and model aeroplanes.

He first came across the Cajon at the age of 13 while watching a Paco de Lucía concert on television. Inspired to make his own, he soon started receiving commissions from friends and acquaintances when they realised that the Cajon was virtually impossible to get hold of in Spain. Pepote began taking these instruments to local shops in his city when he was just 15 years old. This marked the start of his woodwork training, where he focused on the production of musical instruments by studying techniques for making ancient musical instruments and guitars while also completing his studies in industrial furniture design.

Since then, he has been continually developing the instrument and relentlessly perfecting his craft. He came up with an aesthetic based on comfort, tried and tested more than 30 different kinds of wood for construction, created a special unbreakable string for the Cajon and tried 20 different kinds of varnish for the finish. The list goes on. Everything he does revolves around getting the best possible sound out of the instrument and providing the ultimate peace of mind for the percussionist.



## ARTISAN EDITION CAJONS

**FEATURES** Rounded corners and thumb notches for optimal playing comfort and sound  
Ergonomically rounded frontplate with convex contact  
Specially formulated soft rubber feet  
**Martinete, Seguriya, Cantina Line:** Extra thick wooden sound port ring for compression  
Two tuning screws to adjust the tension for each set of strings  
Pop filter on soundhole  
**Seguriya, Cantina, Minera, Bulería, Soleá, Tango Line:** Elegant heat-branding on resonating body

### 1 MARTINETE LINE

**SIZE** 11 1/2" W x 19" H x 12 3/4" D  
**MATERIALS** Resonating body: Solid Wood (15 mm)  
Tulip Poplar (*Liriodendron tulipifera*)  
Frontplate: Brazilian Ironwood (*Phoebe porosa*) with Ukola Woodframe  
**FEATURES** Two sets of 10 adjustable strings (Separately per side)  
6 specially formulated soft rubber feet  
**INCLUDES** Tuning key

### 2 SEGUIRIYA LINE

**SIZE** 11 1/4" W x 19" H x 11 3/4" D  
**MATERIALS** Resonating body: 9-Ply (12 mm)  
Baltic Birch (*Betula Pendula*)  
**AESELIH** Frontplate: Indian Heartwood  
**AESELRW** Frontplate: Rosewood  
**FEATURE** Two sets of 8 adjustable strings (Separately per side)  
**INCLUDES** Tuning key

### 3 CANTINA LINE

**SIZE** **AECLBE, AECLLI** 11 1/4" W x 19" H x 11 3/4" D  
**AECLWN** 12 1/2" W x 18 1/2" H x 12 1/2" D  
**MATERIALS** Resonating body: 9-Ply (12 mm)  
Baltic Birch (*Betula Pendula*)  
**AECLBE** Frontplate: Brown Eucalyptus  
**AECLLI** Frontplate: Limba  
**AECLWN** Frontplate: Walnut  
**FEATURES** **AECLBE, AECLLI** Forward projecting sound port  
Two sets of 6 pre-tuned strings  
**AECLWN** Two sets of 8 adjustable strings from the top (Separately per side)  
Decorative wood inlay  
**INCLUDES** Tuning key

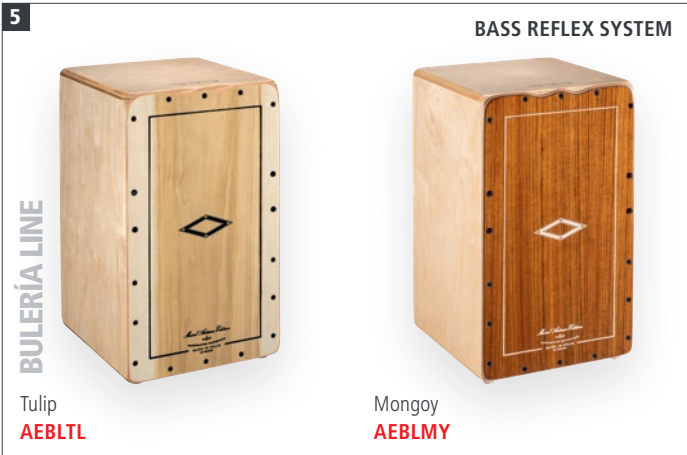

**4 MINERA LINE**  
**SIZE** 11 1/4" W x 19" H x 11 3/4" D  
**MATERIALS** Resonating body: 9-Ply (12 mm) Baltic Birch (*Betula Pendula*)  
**AEMILLI** Frontplate: Limba  
**AEMILBE** Frontplate: Brown Eucalyptus  
**FEATURE** Two sets of 4 pre-tuned strings  
**INCLUDES** Tuning key

**5 BULERÍA LINE**  
**SIZE** 11 1/4" W x 19" H x 11 3/4" D  
**MATERIALS** Resonating body: 9-Ply (12 mm) Baltic Birch (*Betula Pendula*)  
**AEBLMY** Frontplate: Mongoy  
**AEBLTL** Frontplate: Tulip

**FEATURES** Two sets of 5 adjustable strings (Separately per side)  
 Tuning screw to adjust string tension  
 Pop filter on soundhole  
 Bass reflex system  
**INCLUDES** Tuning key

**6 SOLEÁ LINE**  
**SIZE** 11 1/4" W x 19" H x 11 3/4" D  
**MATERIALS** Resonating body: 9-Ply (12 mm) Baltic Birch (*Betula Pendula*)  
 Frontplate: Selected wood  
**FEATURES** Two sets of 5 pre-tuned strings  
 Bass reflex system  
**FINISHES** **AESLEB** Frontplate: Espresso Burst  
**AESLEYB** Frontplate: Ebony Burst  
**AESLRB** Frontplate: Dark Red Burst

**7 TANGO LINE**  
**SIZE** 11 1/4" W x 19" H x 11 3/4" D  
**MATERIALS** Resonating body: 7-Ply (9 mm) Baltic Birch (*Betula Pendula*)  
**AETLBE** Frontplate: Brown Eucalyptus  
**AETLBF** Frontplate: Selected wood  
**AETLGE** Frontplate: Grey Eucalyptus  
**AETLLE** Frontplate: Light Eucalyptus  
**AETLLI** Frontplate: Limba  
**AETLRF** Frontplate: Selected wood  
**AETLSBK** Frontplate: Selected wood  
**FEATURE** Two sets of 3 pre-tuned strings  
**FINISHES** **AETLBF** Frontplate: Blue Fade  
**AETLRF** Frontplate: Red Fade  
**AETLSBK** Frontplate: Satin Black

# WOODCRAFT & HEADLINER® CAJONS



## WOODCRAFT CAJONS **1** **2**

**SIZE** 11 3/4" W x 19 3/4" H x 12" D  
**FEATURES** Custom micro-coiled steel cajon strings; Baltic birch construction; Rounded corners for added comfort; Rubber feet and rear sound port

### **1** WOODCRAFT PROFESSIONAL CAJONS

**MATERIALS** Resonating body: 9-Ply (12 mm) Baltic Birch (*Betula pendula*)  
**WCP100MB** Frontplate: Makah-Burl  
**WCP100MH** Frontplate: Mahogany

### **2** WOODCRAFT CAJONS

**MATERIALS** Resonating body: 7-Ply (9 mm) Baltic Birch (*Betula pendula*)  
**WC100B** Frontplate: Baltic Birch (*Betula pendula*)  
**WC100EB** Frontplate: Espresso Burst

## **3** HEADLINER® SERIES STRING CAJONS

**SIZES** **HCAJ1:** 11 3/4" W x 18" H x 12 1/4" D  
**HCAJ3:** 11 3/4" W x 19 3/4" H x 12" D

**MATERIALS** **HCAJ1AWA, HCAJ3AWA** Resonating body: Eco-friendly medium density fiberboard  
 Frontplate: Stained American White Ash (*Fraxinus Americana* L.)

**HCAJ1NT** Resonating body: Baltic Birch (*Betula pendula*)  
 Frontplate: Baltic Birch (*Betula pendula*)  
**HCAJ3LJ** Resonating body: Eco-friendly medium density fiberboard  
 Frontplate: Baltic Birch (*Betula pendula*)

**FEATURES** Adjustable top corners; Adjustable sizzle effect; Internal fixed cajon strings; Wide sound options  
**HCAJ1:** Anti-slip sitting surface

**INCLUDES** Hex key  
**FINISH** **AWA, NT:** Matte  
**LJ:** Lumberjack

## **4** HEADLINER® SERIES SNARE CAJONS

**SIZE** 11 3/4" W x 18" H x 11 3/4" D  
**MATERIALS** Resonating body: Eco-friendly medium density fiberboard  
**MA** Frontplate: Maple  
**CBF, LPF, PBF, SAF, TRF** Frontplate: American White Ash (*Fraxinus Americana* L.)  
**FEATURES** Dual internal fixed snare wires; Adjustable top corner; Wide sound options  
**FINISHES** **CBF** Frontplate: Charcoal Black Fade  
**LPF** Frontplate: Lilac Purple Fade  
**MA** Frontplate: Natural  
**PBF** Frontplate: Pacific Blue Fade  
**SAF** Frontplate: Sonoran Amber Fade  
**TRF** Frontplate: Tango Red Fade

# SNARECRAFT CAJONS



## 5 FOOT ACTIVATED SNARE SWITCH SNARE SWITCH KNOB



American White Ash  
**SCP100AWA** Walnut  
**SCP100WN**

## 6



Almond Birch  
**SC80AB** Almond Birch  
**SC100AB**



Baltic Birch  
**SC80AB-B** Baltic Birch  
**SC100AB-B**



Baltic Birch  
**SC80B** Baltic Birch  
**SC100B**



Burl Wood  
**SC80BW** Burl Wood  
**SC100BW**



Heart Ash  
**SC80HA** Heart Ash  
**SC100HA**



Blue Burst  
**SC100BLB**



Brown Burst  
**SC100BRB**



Green Burst  
**SC100GRB**



Red Burst  
**SC100RDB**

## 5 SNARECRAFT PROFESSIONAL CAJONS

**SIZE** 11 3/4" W x 19 3/4" H x 12" D  
**MATERIALS** Resonating body: 9-Ply (12 mm) Baltic Birch (*Betula pendula*)  
**SCP100AWA**  
Frontplate: American White Ash (*Fraxinus Americana* L.)  
**SCP100WN**  
Frontplate: Walnut  
**FEATURES** Adjustable snare for both Flamenco and Peruvian styles; Baltic birch construction; Rounded corners for added comfort; Rubber feet and rear sound port  
**SCP100AWA**  
Equipped with a foot activated snare switch  
**SCP100WN**  
Equipped with a snare switch knob on the side of the cajon

## 6 SNARECRAFT CAJONS

**SIZES** **SC80**: 11 3/4" W x 18" H x 11 3/4" D  
**SC100**: 11 3/4" W x 19 3/4" H x 11 3/4" D  
**MATERIALS** **SC80AB, SC100AB**  
Resonating body: 7-Ply (9 mm) Baltic Birch (*Betula pendula*)  
Frontplate: Almond Birch (*Betula pendula*)  
**SC80AB-B, SC100AB-B**  
Resonating body: 7-Ply (9 mm) Almond Birch (*Betula pendula*)  
Frontplate: Baltic Birch (*Betula pendula*)  
**SC80B, SC100B, SC100BLB, SC100BRB, SC100GRB, SC100RDB**  
Resonating body: 7-Ply (9 mm) Baltic Birch (*Betula pendula*)  
Frontplate: Baltic Birch (*Betula pendula*)  
**SC80BW, SC100BW**  
Resonating body: 7-Ply (9 mm) Baltic Birch (*Betula pendula*)  
Frontplate: Burl Wood

## SC80HA, SC100HA

Resonating body: 7-Ply (9 mm) Baltic Birch (*Betula pendula*)  
Frontplate: Heart Ash  
**FEATURES** Dual internal fixed snare wires; Baltic birch construction; Rounded corners for added comfort; Rubber feet and rear sound port  
**FINISHES** **BLB** Frontplate: Blue Burst  
**BRB** Frontplate: Brown Burst  
**GRB** Frontplate: Green Burst  
**RDB** Frontplate: Red Burst

# CAJONS

**1**



Almond Birch  
**JC50AB**

Baltic Birch  
**JC50AB-B**

Baltic Birch  
**JC50B**

Burl Wood  
**JC50BW**

Heart Ash  
**JC50HA**

**2**



Makah-Burl, matte  
**TOPCAJ1MB**

Walnut, matte  
**TOPCAJ2WN**

**3**

**CONTRASTING PLAYING SURFACES ON OPPOSITE SIDES**





Baltic Birch, matte  
**HTOPCAJ3NT**

**4**

**FORWARD FACING SOUND PORTS**



**TTOPCAJ1**

**5**

**BACK**

**SOUND PORT FOR CLEAR PROJECTION**



Black, matte  
**TCAJ1BK**

**6**

**INTERNAL SNARE WIRES**



Natural/Ebony Black, matte  
**BCA2NT/EBK-M**

**DIFFERENT SIZED CHAMBERS ENABLE AN AUTHENTIC BONGO EFFECT**



Super Natural, matte  
**BCA1SNT-M**

**7**

**TWO SOUND OPTIONS**



**TMBX**

**1 JAM CAJONS**

**SIZE** 10 1/2" W x 15" H x 10 1/4" D

**MATERIALS** **JC50AB** Resonating body: 7-Ply (9 mm) Baltic Birch (*Betula pendula*)  
Frontplate: Almond Birch (*Betula pendula*)  
**JC50AB-B** Resonating body: 7-Ply (9 mm) Almond Birch (*Betula pendula*)  
Frontplate: Baltic Birch (*Betula pendula*)  
**JC50B** Resonating body: 7-Ply (9 mm) Baltic Birch (*Betula pendula*)  
Frontplate: Baltic Birch (*Betula pendula*)  
**JC50BW** Resonating body: 7-Ply (9 mm) Baltic Birch (*Betula pendula*)  
Frontplate: Burl Wood  
**JC50HA** Resonating body: 7-Ply (9 mm) Baltic Birch (*Betula pendula*)  
Frontplate: Heart Ash

**FEATURES** Compact size; Baltic birch construction; Dual internal fixed snare wires; Rubber feet and rear sound port

**2 SLAPTAP CAJONS (PATENTED)**

**SIZES** **TOPCAJ1MB** 14 1/2" W x 8 3/4" H x 5 3/4" D  
**TOPCAJ2WN** (Turbo Slaptop) 14 1/2" W x 10" H x 5 3/4" D

**MATERIALS** **TOPCAJ1MB** Resonating body: Eco-friendly medium density fiberboard; Playing surface: Makah-Burl  
**TOPCAJ2WN** (Turbo Slaptop) Resonating body: Eco-friendly medium density fiberboard; Playing surface: Walnut (*Juglans regia* L.)

**FEATURES** Comfortable upright playing style; Forward facing sound ports; Dual internal fixed snare wires; Deep bass and cutting slap tones  
**TOPCAJ2WN** (Turbo Slaptop) Snares on both sides

**3 HYBRID SLAPTAP CAJON**

**SIZE** 14 1/2" W x 10" H x 5 3/4" D

**MATERIAL** Baltic Birch (*Betula pendula*)

**FEATURES** Comfortable and unique X-design; Forward sound projection; Dual internal fixed snare wires for a snare cajon sound on one side; Bongo cajon sound on the opposite side

**4 TRAVEL SLAPTAP CAJON**

**SIZE** 18 3/4" W x 2 3/4" H x 9 1/2" D

**MATERIALS** Resonating body: Eco-friendly medium density fiberboard; Playing surface: Maple

**FEATURES** Comfortable upright playing style; Forward facing sound ports; Dual internal fixed snare wires; Crisp snare cajon sound

**5 TRAVEL CAJON**

**SIZE** 11 3/4"

**MATERIAL** Siam Oak (*Hevea brasiliensis* Muell.-Arg.)

**FEATURES** Internal snare wires; Compact design



caiXoN  
VR-CAIX

caiXoNet  
VR-CAIXN

Set, 2 pcs.  
VR-CAIX/CAIXN

FORWARD FACING SOUND PORT



STACKABLE FOR EASY STORAGE AND TRANSPORTATION

CAJONS



Makah-Burl, matte  
SUBCAJ6MB-M

VERTICAL FORWARD FACING SOUND PORTS



American White Ash, matte  
SUBCAJ1AWA

SUPER LOW FREQUENCY



Walnut, matte  
SUBCAJ5WN

JUMBO BASS SUBWOOFER CAJON

**6 BONGO CAJONS**

**SIZE** 15 3/4" W x 6 3/4" H x 7 1/4" D  
**MATERIAL** Siam Oak (*Hevea brasiliensis* Muell.-Arg.)  
**FEATURES** High and low pitch playing surface; Compact size and light weight  
**BCA2:** Dual internal fixed snare wires

**7 BOXITO**

**SIZE** 11" W x 8 1/2" H x 5 3/4" D  
**MATERIALS** Resonating body: Baltic Birch (*Betula pendula*); Playing surface: Baltic Birch (*Betula pendula*), Exotic Zebrano  
**FEATURES** Dual playing surfaces bongo/snare; Internal fixed snare wires; Natural wood tone

**8 CAIXON & CAIXONET**

**SIZES** **VR-CAIX** (caiXoN) 11 1/2" W x 26 1/4" H x 12" D  
**VR-CAIXN** (caiXoNet) 10 1/2" W x 26 1/4" H x 9 1/2" D  
**MATERIALS** Resonating body: Baltic Birch (*Betula pendula*); Playing surface: Striped Onyx  
**FEATURES** Internal snare wires for cutting snare slaps; Perfect for seated players; Forward facing sound port  
**VR-CAIX:** Deep bass tones  
**VR-CAIXN:** Higher tones  
**VR-CAIX/CAIXN:** Includes large caiXoN and smaller caiXoNet; Stackable for easy storage and transportation

**9 VERTICAL SUBWOOFER CAJON**

**SIZE** 15 1/2" W x 19 1/4" H x 11 3/4" D  
**MATERIALS** Resonating body: Eco-friendly medium density fiberboard; Frontplate: Makah-Burl  
**FEATURE** Dual internal fixed snare wires and bass reflex channel

**10 SUBWOOFER CAJONS**

**SIZES** **SUBCAJ1AWA** 11 3/4" W x 19 3/4" H x 12 1/4" D  
**SUBCAJ5WN** 13 1/2" W x 19 3/4" H x 13 3/4" D  
**MATERIALS** Resonating body: Eco-friendly medium density fiberboard  
**SUBCAJ1AWA** Frontplate: American White Ash (*Fraxinus Americana* L.)  
**SUBCAJ5WN** Frontplate: Walnut (*Juglans regia* L.)  
**FEATURES** Forward projecting sound port; Dual internal fixed snare wires

# PICKUP CAJONS

**1** **PIEZO PICKUP WITH VOLUME AND TONE CONTROL**



**SOLEÁ LINE**

Dark Olive Burst  
**PAESLDOB**

**2**



Baltic Birch  
**PWC100B**

Makah-Burl  
**PWCP100MB**

**3**



Baltic Birch  
**PSC100NT**

Baltic Birch  
**PSC100B**

**4**



Baltic Birch  
**PJC50B**

**5**



Baltic Birch  
**PSUBCAJ6B**

**6** **INDIVIDUAL SNARE AND BASS CONTROL**



Walnut  
**PTOPCAJ2WN**

Mahogany  
**PTOPCAJ4MH-M**

**1 ARTISAN EDITION PICKUP CAJON, SOLEÁ LINE**

**SIZE** 11 1/4" W x 19" H x 11 3/4" D  
**MATERIALS** Resonating body: 9-Ply (12 mm) Baltic Birch (*Betula pendula*)  
 Frontplate: Dark Olive Burst  
**FEATURES** Piezo pickup with volume and tone control; Two sets of 5 pre-tuned strings; Rounded corners and thumb notches for optimal playing comfort and sound; Ergonomically rounded frontplate with convex contact; Bass reflex system

**2 PICKUP WOODCRAFT SERIES CAJONS**

**SIZE** **PWCP100MB** (Woodcraft Professional) 11 3/4" W x 19 3/4" H x 12" D  
**PWC100B** (Woodcraft) 11 3/4" W x 19 3/4" H x 12" D  
**MATERIALS** Resonating body: Baltic Birch (*Betula pendula*)

**FEATURES** **PWCP100MB** (Woodcraft Professional) Frontplate: Makah-Burl  
**PWC100B** (Woodcraft) Frontplate: Baltic Birch (*Betula pendula*)  
**FEATURES** Three Piezo pickups for snare and bass sounds; Rubber feet and rear sound port  
**COLOURS** **PWCP100MB** Resonating body: Black  
**PWC100B** Resonating body: Natural

**3 PICKUP SNARECRAFT SERIES CAJONS**

**SIZE** 11 3/4" W x 19 3/4" H x 11 3/4" D  
**MATERIALS** Resonating body: Baltic Birch (*Betula pendula*)  
 Frontplate: Baltic Birch (*Betula pendula*)  
**FEATURES** Three Piezo pickups for snare and bass sounds; Baltic birch construction  
**COLOURS** **PSC100B** Resonating body: Black

**PSC100NT**  
 Resonating body: Natural

**4 PICKUP JAM CAJON**

**SIZE** 10 1/2" W x 15" H x 10" D  
**MATERIALS** Resonating body: Baltic Birch (*Betula pendula*)  
 Frontplate: Baltic Birch (*Betula pendula*)  
**FEATURES** Compact size; Dual internal fixed snare wires; Piezo pickup with volume control  
**COLOUR** Natural



**5 PICKUP VERTICAL SUBWOOFER CAJON**

**SIZE** 15 1/2" W x 19 1/4" H x 11 3/4" D  
**MATERIALS** Resonating body: Eco-friendly medium density fiberboard  
 Frontplate: Baltic Birch (*Betula pendula*)  
**FEATURES** Vertical forward-facing sound ports; Piezo pickup with volume and tone control; Dual internal fixed snare wires





**7**

Birch Wood  
**MPDC1**

DIGITAL CAJON FOR EXPANDED SOUND OPTIONS AND SILENT PRACTICE

**DIGITAL CAJON SOUNDS**

- 0 - MEINL Subwoofer Cajon + MEINL Tambourine
- 1 - MEINL Snarecraft Cajon + MEINL Splash Cymbal
- 2 - MEINL Cantina Line Artisan Cajon + MEINL Closed Hihat Cymbal
- 3 - MEINL Slaptop Cajon + Hand Clap
- 4 - MEINL Woodcraft Cajon + MEINL Crash Cymbal
- 5 - Rock Drum Kit + MEINL Closed Hihat Cymbal
- 6 - Drum Machine + MEINL Ride Cymbal
- 7 - MEINL Marathon® Classic Congas
- 8 - MEINL Fibercraft Bongos + MEINL Percussion Block
- 9 - MEINL Diego Galé Signature Timbales + MEINL Steel Craft Cowbell

**9**



Baltic Birch  
**MMCS**

**CAJON MICROPHONE STAND (SEE PAGE 116)**



**CMS**

**8**

TWO 4.5" 20-WATT SPEAKERS



Baltic Birch  
**MPSCAJ**

PRACTICE TO MUSIC OR INCORPORATE LOOPS IN YOUR PERFORMANCES

**10**



**MIC-PERC**

**11**



**PA-CAJ**

**MICROPHONE CAJON CLAMP (SEE PAGE 123)**



**MPMCC**

**6 PICKUP SLAPTOP CAJONS (PATENTED)**

**SIZES** **PTOPCAJ2WN** (Turbo Slaptop)  
14 1/2" W x 10" H x 5 3/4" D  
**PTOPCAJ4MH-M**  
15 1/2" W x 8 1/2" H x 7 1/2" D

**MATERIALS** **PTOPCAJ2WN** (Turbo Slaptop)  
Resonating body: Baltic Birch (*Betula pendula*)  
Playing surface: Walnut (*Juglans regia* L.)  
**PTOPCAJ4MH-M**  
Resonating body: Eco-friendly medium density fiberboard  
Playing surface: Mahogany

**FEATURES** Passive pickup system with high quality output jack; Individual snare, bass, and tone control; Playing surface with dual internal fixed snare wires; Forward facing sound ports  
**PTOPCAJ2WN** (Turbo Slaptop)  
Snares on both sides

**7 DIGITAL CAJON**

**SIZE** 12" W x 20" H x 12" D

**MATERIALS** Resonating body: Birch Wood  
Playing surface: Open cell acoustic foam

**FEATURES** Four rubber trigger pads in a natural cajon playing position; Ten pre-programmed digital sounds

**INCLUDES** Power supply; Foot switch

**COLOUR** Black

**8 SPEAKER CAJON**

**SIZE** 11 3/4" W x 19 3/4" H x 11 3/4" D

**MATERIALS** Resonating body: Baltic Birch (*Betula pendula*)  
Frontplate: Baltic Birch (*Betula pendula*)

**FEATURES** Practice to music or incorporate loops in your performances; Supports wireless connection with your phone

**INCLUDES** Micro SD card

**COLOUR** Resonating body: Black

**9 MINI CAJON SPEAKER**

**SIZE** 5 3/4" W x 8 3/4" H x 5 3/4" D

**MATERIALS** Resonating body: 5-Ply (6 mm) Baltic Birch (*Betula pendula*)  
Frontplate: Baltic Birch (*Betula pendula*)

**FEATURES** Listen to your favorite music or podcast; Supports wireless, USB and auxiliary connection; Great gift idea for percussionists

**10 PERCUSSION MICROPHONE**

**FEATURES** Low-profile condenser microphone with adhesive backing; Great for cajons, congas, djembes or frame drums

**INCLUDES** Eighth-inch cable to quarter-inch adapter

**11 CAJON PREAMP**

**FEATURES** Robust Cajon Pickup/Preamp; Wide range tone control; High-quality signal output; Fits most cajons

# MINI & MAKE YOUR OWN CAJONS

**1**

MINIATURE SIZE OF A CAJON WITH INTERNAL FIXED SNARE WIRES



Almond Birch  
**MC1AB**

Baltic Birch  
**MC1AB-B**

Baltic Birch  
**MC1B**

Burl Wood  
**MC1BW**

Heart Ash  
**MC1HA**



**2**

ALL NEEDED TOOLS INCLUDED



Burl Wood  
**DMYO-CAJ-BU**

DELUXE MODEL  
FEATURES LARGER SIZE

**3**



Baltic Birch  
**MYO-CAJ**

**4**

POPS UP FROM A FLAT PIECE INTO A FULL SIZE CAJON



Cajon2Go  
**VR-CAJ2GO**

**5**



Baltic Birch  
**MYO-BCAJ**

**3**



Ovangkol  
**MYO-CAJ-OV**

ASSEMBLY INSTRUCTION COMES  
IN DIFFERENT LANGUAGES

**6**



**MYO-TOOLS**

<p><b>1 MINI CAJONS</b></p> <p><b>SIZE</b> 5 3/4" W x 8 3/4" H x 5 3/4" D</p> <p><b>MATERIALS</b> <b>MC1AB</b> Resonating body: 5-Ply (6 mm) Baltic Birch (<i>Betula pendula</i>) Frontplate: Almond Birch (<i>Betula pendula</i>)</p> <p><b>MC1AB-B</b> Resonating body: 5-Ply (6 mm) Almond Birch (<i>Betula pendula</i>) Frontplate: Baltic Birch (<i>Betula pendula</i>)</p> <p><b>MC1B</b> Resonating body: 5-Ply (6 mm) Baltic Birch (<i>Betula pendula</i>) Frontplate: Baltic Birch (<i>Betula pendula</i>)</p> <p><b>MC1BW</b> Resonating body: 5-Ply (6 mm) Baltic Birch (<i>Betula pendula</i>) Frontplate: Burl Wood</p>	<p><b>MC1HA</b> Resonating body: 5-Ply (6 mm) Baltic Birch (<i>Betula pendula</i>) Frontplate: Heart Ash</p> <p><b>FEATURES</b> Internal fixed snare wires; Miniature size; Birch construction; Great gift idea</p> <p><b>MAKE YOUR OWN</b> <b>2 3 4</b></p> <p><b>CONTAINS</b> All of the materials and assembly instructions for completing the cajon</p> <p><b>2 DELUXE MAKE YOUR OWN CAJON</b></p> <p><b>SIZE</b> 12" W x 19 1/4" H x 12" D</p> <p><b>MATERIALS</b> Resonating body: Baltic Birch (<i>Betula pendula</i>) Frontplate: Burl Wood</p> <p><b>INCLUDES</b> All of the tools for completing the cajon</p> <p><b>3 MAKE YOUR OWN CAJONS</b></p> <p><b>SIZE</b> 11 3/4" W x 18" H x 11 3/4" D</p>	<p><b>MATERIALS</b> Resonating body: Baltic Birch (<i>Betula pendula</i>)</p> <p><b>MYO-CAJ</b> Frontplate: Baltic Birch (<i>Betula pendula</i>)</p> <p><b>MYO-CAJ-OV</b> Frontplate: Ovangkol (<i>Guibourtia ehie</i>) Steel snare wires</p> <p><b>COLOUR</b> Natural</p> <p><b>4 CAJON2GO</b></p> <p><b>SIZE</b> 13 1/2" W x 18" H x 12 1/2" D</p> <p><b>MATERIAL</b> Cardboard</p> <p><b>FEATURES</b> Folds from a single flat piece into a full size cajon; Internal fixed set of snare wires; Comfortably holds up to 150 kg / 330 lbs; Naturally deep bass and crisp snare sounds</p> <p><b>5 MAKE YOUR OWN BONGO CAJON</b></p> <p><b>SIZE</b> 15 3/4" W x 6 3/4" H x 7 1/4" D</p>
--	--	--

# CAJON PEDALS



CAJONS & CAJON PEDALS

**7**

SPECIALLY POSITIONED CURVED STEEL BAR WITH DIRECT DRIVE



TMSTCP

**8** NEW



TMCP-2

**9**

ADJUSTABLE SPRING TENSION ON BOTH THE PEDAL AND THE MOUNT



TMCP

BASSBOX / SNAREBOX PEDAL (SEE PAGE 57)



TMBP

**10**

CAN BE PLAYED WITH YOUR HEEL OR TOES



TMSTCP-2

**12**

ADJUSTABLE BRASS JINGLES



Soft foam  
CPB2

**13**

DELIVERS HEAVY, FULL STROKES



Polymer bristles  
CPB3

**14**

FOR DEEP AND PUNCHY NOTES



Soft foam  
CPB4

**15**

GREAT FOR LOW VOLUME SETTINGS



Artificial fur  
CPB5

**MATERIAL** Baltic Birch (*Betula pendula*)  
**COLOUR** Natural

**6 MAKE YOUR OWN CAJON TOOL BOX**  
**CONTAINS** 1 x screwdriver; 1 x wood glue; 2 x tension straps; 2 x sanding pads (coarse and fine)  
**FEATURE** One-stop shop for all necessary tools to complete the Meinl Make Your Own Cajons and Bongo Cajon

**7 DIRECT DRIVE CAJON PEDAL**  
**MATERIAL** Steel  
**FEATURES** Cradle-like mount fits all common cajons; Adjustable spring tension; Natural foot position for ease of use

**8 PROFESSIONAL CAJON PEDAL**  
**MATERIAL** Steel  
**FEATURES** Position anywhere for optimal playability; For right and left-footed players

**9 CAJON PEDAL**  
**MATERIALS** Steel; Synthetic  
**FEATURES** Cradle-like mount fits all common cajons; Ultra-smooth and durable cable; Position anywhere for optimal playability  
**INCLUDES** Drum key; Soft foam beater

**10 DIRECT DRIVE HEEL ACTIVATED CAJON PEDAL**  
**MATERIAL** Steel  
**FEATURES** Simple design for steady bass drum rhythms; Cradle-like mount fits most cajons

**11 HAMMER HEAD CAJON & BASS DRUM BEATER**  
**MATERIAL** Foam rubber  
**FEATURES** Soft foam rubber draws a deep bass sound from cajons; Dual playing surfaces for a variety of boom and punch

**12 JINGLE CONTACT CAJON & BASS DRUM BEATER**  
**MATERIALS** Soft foam rubber; Brass jingles  
**FEATURE** Easily turn the jingles on or off as desired throughout your set

**13 BRUSH CAJON & BASS DRUM BEATER**  
**MATERIAL** Rippled polymer bristles  
**FEATURES** Extra thick set of wavy polymer bristles; Two adjustable control rings; Warm, slightly mellow attack

**14 STANDARD CAJON & BASS DRUM BEATER**  
**MATERIAL** Soft foam rubber

**15 WOOLLY MAMMOTH CAJON BEATER**  
**MATERIALS** Artificial fur; Soft foam

# CAJON DRUM SETS

1



MORE INFO

MAY BE EASILY ARRANGED FOR RIGHT OR LEFT HANDED PLAYERS



Set  
**CAJ-DRUMSET**

## PORTABLE RHYTHM STATION



2



**MDTK**

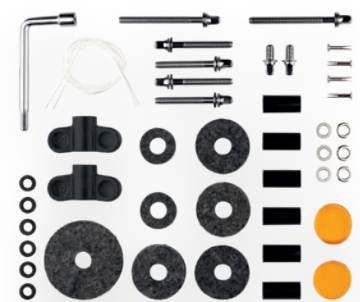

### 1 CAJON DRUM SET

- CONTAINS**
- Birch wood cajon without snares for enhanced bass
  - Cajon Pedal
  - Mountable Cajon Snare including silicone protection cover
  - Multi-Clamp
  - HCS 13" hihat cymbal pair with Low Hat
  - Bamboo Flex Multi-Rods for Cajon
  - Cajon Blanket with pockets for accessories
  - Luis Conte Live Shaker
  - Cajon Gig Bag

### FEATURES

May be easily arranged for right or left handed players  
This set includes everything needed for players looking to perform their normal drum set rhythms in smaller, intimate acoustic settings  
The elements of this set give you the same feeling as sitting down at a drum kit

### 2 DRUM TECH KIT

- CONTAINS**
- 1 x L-Shaped Drum Key
  - 4 x Drum Honey Gel Pads
  - 6 x Synthetic Cymbal Sleeves
  - 4 x Steel Cymbal Rivets
  - 4 x Cymbal Felts
  - 2 x Hihat Clutch Felts
  - 1 x Hihat Base Felt
  - 2 x 8 mm Wing Nuts
  - 6 x Metal Washers
  - 6 x Synthetic Washers
  - 2 x Nylon Snare Cords
  - 2 x Short Tension Rods
  - 4 x Medium Tension Rods
  - 2 x Long Tension Rods

### FEATURES

Includes 14 of the most common and important tools for drummers and techs; For gig emergencies, routine maintenance, restoration or replacing lost parts

### INCLUDES

Storage container for organization

3



MORE INFO

CONVERTS ANY STANDARD CAJON INTO A BASS DRUM



Set  
**CAJ-KIT**

4

CUTTING SNARE SOUND



**MCS1-BK**



5

SHIELDS YOUR SNARE CAJON FROM STICK MARKS OR SCRATCHES



**SCOVER**



**3 CAJON DRUM SET CONVERSION KIT**

- CONTAINS** Direct Drive Cajon Pedal  
Mountable Cajon Snare including silicone protection cover  
Multi-Clamp  
HCS 13" hihat cymbal pair with Low Hat  
Bamboo Flex Multi-Rods for Cajon  
Cajon Blanket with pockets for accessories  
Luis Conte Live Shaker  
Cajon Gig Bag
- FEATURES** Converts any standard cajon into a bass drum (cajon not included)  
Expand your cajon into a small, reduced volume drum set  
Low-key stage footprint  
Perfect for acoustic shows, jam sessions, or street performances

**4 MOUNTABLE CAJON SNARE**

- SIZE** 7 1/2"
- MATERIAL** Siam Oak (*Hevea brasiliensis* Muell.-Arg.)
- FEATURES** Internal Snare Wires  
Standard 3/8" rod mounting bracket
- INCLUDES** L-shaped rod with knurled surface
- COLOUR** **BK**: Black

**5 SILICONE PROTECTION COVER**

- SIZE** 7 1/2"
- MATERIAL** Silicone
- FEATURES** Shields your snare cajon from stick marks or scratches  
Removable at any time

# CAJON DRUM SETS



## 1 COCKTAIL CAJON KIT

**CONTAINS** Cocktail Cajon; Tom Tap; Snare Tap; Bongo Cajon Tap; Husk Brush (SB307); Foot Pedal (TMBP); Pedal Beater (CPB4); 3 x L-shaped rod (MC-R5); Splitter

## 2 KICK DRUM CAJON

**SIZE** 11 3/4" W x 19 3/4" H x 11 3/4" D  
**MATERIALS** Resonating body: 7-Ply (9 mm) Baltic Birch (*Betula pendula*)  
Frontplate: Baltic Birch (*Betula pendula*)  
**FEATURES** Multiple attachments to build an acoustic drum setup; Full size cajon without snares or strings for pure bass tone  
**INCLUDES** Cymbal arm; Z-shape rod (plus mounts); pedal attachment plate; cajon beater

## 3 COMPACT PERCUSSION PAD

**SIZE** 6 1/2"  
**MATERIAL** ABS

**FEATURES** 5 pre-programmed sounds; Ideal for multi-instrumentalists and percussionists; Sensitive rubber surface for responsive hand and stick notes

**INCLUDES** Rechargeable battery and USB-C cable  
**SOUNDS** 9000, SDS & 808 Snare, Tambourine, Hand Clap

## 4 THE ULTIMATE PERCUSSION SAMPLE BOX

**MATERIAL** Aluminum  
**FEATURES** Converts the input signal into percussion sound effects; Can use any analog stomp box or electronic trigger pad as signal generator; Controller for volume, sound selection, touch response; High-quality 1/4" TRS input and output jack; 3/8" eye bolt mount; Rechargeable battery and USB-C included (cable not included); Built-in OLED screen

## 5 MERGER

**MATERIAL** Aluminum  
**FEATURES** Combine multiple percussion audio signals into one output; Contains 6 inputs, 1 XLR output and 1 AUX input

## 6 INSTRUMENT CABLES

**SIZES** **MPIC-5:** 5 ft / 1.5 m  
**MPIC-10:** 10 ft / 3 m  
**MPIC-15:** 15 ft / 4.5 m  
**MPIC-20:** 20 ft / 6 m  
**MPIC-30:** 30 ft / 9 m  
**FEATURES** 8 mm diameter with high-quality 1/4" straight connectors; Wire gauge: 24 AWG

## 7 COCKTAIL CAJON INSTRUMENT CABLE SET

**CONTAINS** 4 x 5 ft Instrument Cable (MPIC-5)  
1 x 30 ft Instrument Cable (MPIC-30)  
**FEATURE** 5-piece Meinl Percussion Instrument Cable set for the Meinl Cocktail Cajon Kit

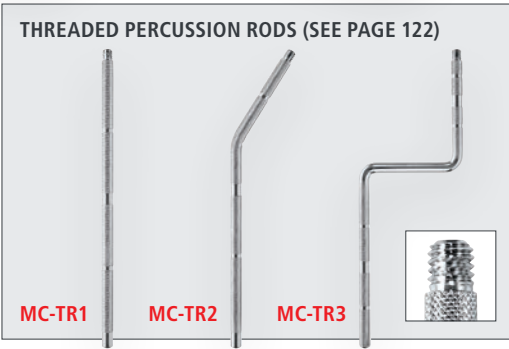
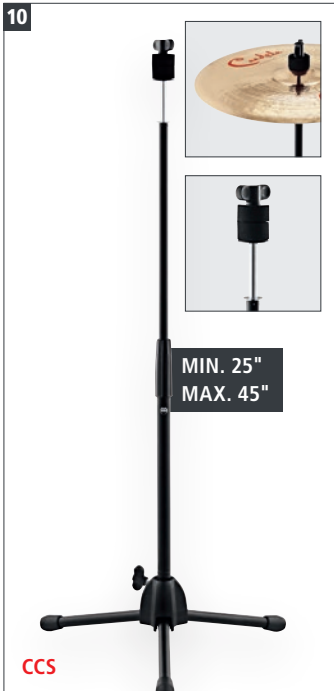
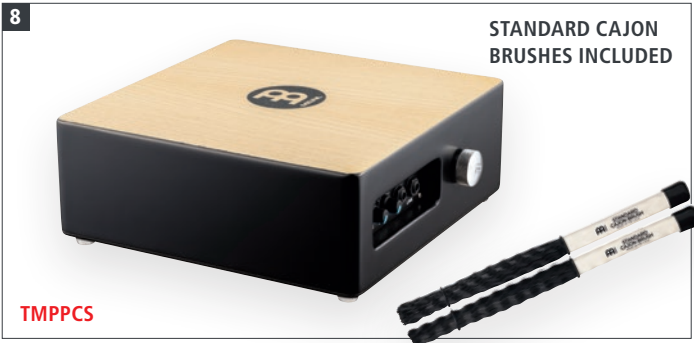

**8 PROFESSIONAL PICKUP CAJON SNARE**  
 SIZE 13" W x 6" H x 13" D  
 MATERIALS Resonating body: MDF  
 Playing surface: American White Ash (*Fraxinus Americana* L.)  
 INCLUDES Standard Cajon Brushes (SB305)

**CAJON DRUM SET STANDS 9 10 11**  
 MATERIAL Black powder coated steel  
 FEATURE Foldable legs, height adjustable

**9 CAJON HIHAT STAND**  
 FEATURES Standard hi-hat clutch and padded seat;  
 Fixed internal rod for closed hi-hat sound

**10 CAJON CYMBAL STAND**  
 FEATURES Standard cymbal stand top;  
 Use with any cymbal type

**11 CAJON ADD-ON STAND**  
 FEATURE 3/8" threaded connector top

**CAJON TAPS 12 13 14**  
 SIZE 5 3/4"  
 MATERIAL Siam Oak (*Hevea brasiliensis* Muell.-Arg.)  
 FEATURE Threaded 3/8" connection underneath  
 FINISH Black

**12 CAJON JINGLE TAP**  
 FEATURE Stainless steel jingles for bright accents

**13 CAJON SNARE TAP**  
 FEATURE Internal snares for high pitched snare cajon sound

**14 CAJON TOM TAP**  
 FEATURE Hollow inside for a high pitched "tom" sound

**15 MOUNTABLE CAJON SNARE WITH THREADED 3/8" CONNECTION**  
 SIZE 7 1/2"  
 MATERIAL Siam Oak (*Hevea brasiliensis* Muell.-Arg.)  
 INCLUDES Silicone Protection Cover  
 COLOUR **BK**: Black

# CAJON ADD-ONS

**1**

DESIGNED TO HOLD OUR CAJON ADD-ONS CLOSE TO THE PLAYING SURFACE

Medium **CSM-M**      Large **CSM-L**

**2**

**WC1-M**

**3**      **STAINLESS STEEL JINGLES**

**WJC1-M**

**ADD NEW SOUNDS TO YOUR CAJON**

**4**      **STAINLESS STEEL JINGLES**

**JT-S-BK**

**5**      **EXTRA POCKET FOR SMALL PERCUSSION**

**CAJ-BLK**

**6**      **INTERNAL SNARE EFFECT**

**WSS1BK**

**7**

Small **CCAB-S**      Medium **CCAB**

**8**

**TMCTK**

- 1 CAJON SIDE MOUNTS**  
**SIZES** **M:** Medium  
**L:** Large  
**MATERIAL** Siam Oak (*Hevea brasiliensis* Muell.-Arg.)  
**FEATURES** Easy handling; Hook and loop fastener goes on any surface; Offers better cajon accessory placement  
**COLOUR** Black
- 2 CAJON CASTANET**  
**SIZE** **M:** Medium  
**MATERIAL** Siam Oak (*Hevea brasiliensis* Muell.-Arg.)  
**FEATURES** Spring-opened; Hook and loop fastener goes on any surface  
**COLOUR** Black  
**FINISH** Matte
- 3 CAJON JINGLE CASTANET**  
**SIZE** **M:** Medium  
**MATERIAL** Siam Oak (*Hevea brasiliensis* Muell.-Arg.)

- FEATURES** Spring-opened; Hook and loop fastener goes on any surface; Stainless steel jingles  
**COLOUR** Black  
**FINISH** Matte
- 4 JINGLE TAP**  
**SIZE** Medium  
**MATERIAL** Siam Oak (*Hevea brasiliensis* Muell.-Arg.)  
**FEATURES** Stainless steel jingles; Hook and loop fastener goes on any surface  
**COLOUR** **BK:** Black
- 5 CAJON BLANKET**  
**MATERIAL** Heavy-duty nylon  
**FEATURES** Fits on any cajon; Hook and loop fastener to mount additional add-ons  
**COLOUR** Black
- 6 WOOD SIDE SNARE**  
**MATERIAL** Siam Oak (*Hevea brasiliensis* Muell.-Arg.)

- FEATURES** Internal snare effect; Hook and loop fastener attaches to Cajon body; Ergonomic shape; Unobtrusive low profile  
**COLOUR** **BK:** Black  
**FINISH** Matte
- 7 CAJON TURBO CABASAS**  
**SIZES** **CCAB-S:** Small  
**CCAB:** Medium (traditional size)  
**MATERIALS** Steel chain and stainless steel cylinder  
**FEATURES** Add cabasa or loose hihat effects to cajon grooves; Five sound ports for extra projection
- 8 CAJON KINETIC TUNING KEY**  
**MATERIAL** Molded ABS  
**FEATURES** Adjust cajon string tension and cajon frontplate screws; Dual crosshead screw-driver and hex key; Wide wing Meinl logo designed for a firm grip



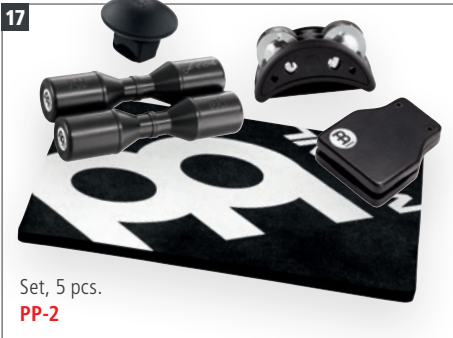

**9 KNEE PAD JINGLE TAP & KNEE PAD SNARE TAP**  
**MATERIAL** Siam Oak (*Hevea brasiliensis* Muell.-Arg.)  
**FEATURES** Strap with hook and loop fastener to mount on your leg  
**KP-JT-BK:** Stainless steel jingles  
**KP-ST-BK:** Snare effect  
**COLOUR** **BK:** Black

**10 MOTION SHAKER**  
**MATERIAL** Synthetic  
**FEATURES** Comfortable to wear on your fingers; Cutting shaker sound  
**COLOUR** **BK:** Black

**11 CAJON RING CASTANETS**  
**SIZE** Large  
**MATERIALS** **CRC1BK:** Siam Oak (*Hevea brasiliensis* Muell.-Arg.)  
**PCRC1BK:** Synthetic

**COLOUR** **BK:** Black  
**12 FINGER JINGLES**  
**MATERIALS** Siam Oak (*Hevea brasiliensis* Muell.-Arg.)  
**FJS1A:** Aluminum jingles  
**FJS1S:** Stainless steel jingles

**13 CAJON PEDAL MOUNT**  
**MATERIAL** Baltic Birch (*Betula pendula*)  
**FEATURES** Play your cajon just like a kick drum; Accommodates any size cajon; Fits all bass drum pedals; Adjustable wooden plate secures your cajon

**14 SYNTHETIC LEATHER CAJON SEATS**  
**MATERIAL** Sleek faux leather  
**FINISHES** **GR:** Grey  
**VBR:** Vintage Brown

**15 DELUXE CAJON SEATS**  
**SIZE** 9 3/4" x 9 1/2"  
**MATERIALS** Inner material foam  
 Outer material leatherette  
**FEATURES** Provides comfort while sitting on your cajon; Filled with extra-thick padding; Elegant cross-stitching for high-end look and durability; Special underside surface grips any cajon (no adhesives necessary)  
**COLOURS** **DCS:** Black  
**DCS-R:** Bordeaux

**16 CAJON PAD**  
**SIZE** 10" x 10"  
**MATERIAL** Soft foam

**17 CAJON PERC PACK**  
**CONTAINS** Cajon Pad; Compact Foot Tambourine; Motion Shaker; Cajon Castanet, large; Luis Conte Live Shaker

# PERCUSSION STOMP BOXES & EFFECTS PEDALS

**1**

Kick  
**STB1**

Cowbell  
**STB2**

Clap  
**STB3**

Tambourine  
**STB4**

**2**

**NEW**

12 sounds  
**STB6**

**NEW**

14 sounds  
**STB7**

**3**

**CREATES A FOOT STOMPING ANALOG SIGNAL**

Analog  
**MPS1**

HiHat  
**STB5**

**NEW**

16 sounds  
**STB8**

**4**

**A WHOLE PERCUSSION KIT IN A BOX**

**FX5**

**FX20**

**5**

**MPTP**

## 1 PERCUSSION STOMP BOXES

**MATERIAL** Aluminum

**FEATURES** Create hands-free beats by tapping your foot; Pre-programmed percussion sound effect; Perfect for cajon players, guitarists and multi-instrumentalists; High-quality 1/4" output jack

**SOUNDS** **STB1:** Kick  
**STB2:** Cowbell  
**STB3:** Clap  
**STB4:** Tambourine  
**STB5:** HiHat

## 2 THE ULTIMATE STOMP BOXES

**MATERIAL** Aluminum

**FEATURES** Create hands-free beats by tapping your foot; Perfect for cajon players, guitarists or multi-instrumentalists; High-quality 1/4" TRS input and output jack; Runs with 2 x AA 1.5V batteries (not included)

**SOUNDS** **STB6:** Kick Bass; Pop Kick; Soft Kick; 808 Bass; 909 Bass; SDS Bass; Cannon Kick; Doom Kick; Bass 'n' Ride; Oriental; Doumbek Bass; 808 Subkick  
**STB7:** Soul Snare; 9000 Snare; 909 Snare; 808 Snare; Brass Snare; SDS Snare; Pop Snare; Doumbek Slap; HipHop Snare; Reggae Snare; Snare + Clap; Snare + Tambourine; Brush Snare; Sidestick  
**STB8:** Tambourine; Cowbell; Clap; Shaker; Pedal HiHat; Woodblock; Bongo; Conga; Darbuka; Timbale; Djembe; Slight Bell; Maracas; Claves; Guiro; Crasher

## 3 PERCUSSION STOMP BOX, ANALOG

**MATERIAL** Solid Mahogany body

**FEATURES** Perfect for percussionists and multi-instrumentalists; 1/4" input and output jacks; Creates a foot stomping analog signal; Built-in Piezo pickups with volume control

**INCLUDES** L-shaped soft foam beater

## 4 EFFECTS PEDALS

**MATERIALS** ABS; Steel

**FEATURES** Ideal for multi-instrumentalists and percussionists  
**FX5:** 5 pre-programmed sounds; Hands-free beats  
**FX20:** Ten pre-programmed percussion samples and ten custom samples; Weighted body for a sturdy feel; Highly dynamic pedal with smooth spring back an no sound interference

**INCLUDES** **FX5:** Rechargeable battery, USB-C cable  
**FX20:** Micro SD card and power supply with international adapters

**SOUNDS** **FX5:** Pop; Doom; SDS; 808 Sub; Soft Kick  
**FX20:** Kick Bass; Soft Kick; 808 Bass; 808 Snare; HiHat; Clave; Hand Clap; Cowbell; Straight Tambourine; Shaker

# BASSBOXES & SNAREBOXES



FOOT PERCUSSION

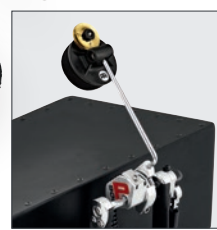

## 5 TRIGGER PEDAL

**MATERIAL** ABS; Steel  
**FEATURES** Pedal activated trigger; Transmits sounds from your sound module; Hands-free use

## 6 BASSBOX & PICKUP BASSBOX

**SIZE** 17 1/2" W x 6 3/4" H x 11 3/4" D  
**MATERIAL** Resonating body: Baltic Birch (*Betula pendula*)  
**FEATURES** Perfect for guitarists and singers; Immense bass sound  
**PBASSBOX:** Piezo pickup with high quality output jack  
**INCLUDES** L-shaped soft foam beater  
**COLOUR** Black  
**FINISH** Matte

## 7 SNAREBOX & PICKUP SNAREBOX

**SIZE** 7 1/2" W x 7 1/2" H x 13" D  
**MATERIAL** Baltic Birch (*Betula pendula*)

**FEATURES** Perfect for guitarists and singers  
**PSNAREBOX:** Piezo pickup with high quality output jack  
**INCLUDES** L-shaped felt beater  
**COLOUR** Black  
**FINISH** Matte

## 8 BASSBOX BEATER

**MATERIAL** Soft foam rubber  
**FEATURE** Punchy response

## 9 SNAREBOX BEATER

**MATERIAL** Felt  
**FEATURE** Crisp snare response

## 10 JINGLE CONTACT BASSBOX/SNAREBOX BEATER

**MATERIALS** Soft foam rubber; Brass jingles  
**FEATURE** Soft L-shaped foam rubber beater with adjustable brass jingles

## 11 HAMMER HEAD BASSBOX/SNAREBOX BEATER

**MATERIAL** Foam rubber  
**FEATURES** Hammer Head shape for a pronounced kick sound; Dual playing surfaces for boom or punch; Draws out a naturally deep tone

## 12 WOOLLY MAMMOTH BASSBOX/SNAREBOX BEATER

**MATERIALS** Artificial fur; Soft foam  
**FEATURES** Woolly Mammoth beater produces a soft kick sound; Delivers a mellow attack for low volume and texture

## 13 BASSBOX/SNAREBOX PEDAL

**MATERIAL** Steel  
**FEATURE** Adjustable spring tension to dial in your comfort zone

# FOOT PERCUSSION



## 1 FOOT TAMBOURINE

**MATERIALS** Siam Oak (*Hevea brasiliensis* Muell.-Arg.)  
Stainless steel jingles  
**FEATURE** Hassle-free mounting

## 2 COMPACT FOOT TAMBOURINE

**MATERIALS** Synthetic  
Stainless steel jingles  
**FEATURE** Attaches quickly and easily to foot via elastic strap

## 3 CAJON FOOT TAMBOURINE

**MATERIALS** Siam Oak (*Hevea brasiliensis* Muell.-Arg.)  
Stainless steel jingles  
**FEATURES** 5 pairs of stainless steel jingles  
Easily mountable

## 4 FOOT SHAKER

**MATERIAL** Synthetic  
**FEATURES** Easy mountable  
Shaker mounted at a special angle for precise control

## 5 CAJON FOOT CASTANET

**MATERIALS** Siam Oak (*Hevea brasiliensis* Muell.-Arg.)  
Synthetic  
**FEATURES** Traditional castanet sound  
Easily mountable  
Pair of synthetic castanets

## 6 HEEL TAMBOURINE

**MATERIALS** Siam Oak (*Hevea brasiliensis* Muell.-Arg.)  
Synthetic  
Stainless steel jingles  
**FEATURES** Stainless steel jingles for a bright full sound  
Shoehorn design fits comfortably against your heel  
Great accessory for hands free playing

## 7 PROFESSIONAL HEEL TAMBOURINE

**MATERIALS** Siam Oak (*Hevea brasiliensis* Muell.-Arg.)  
Synthetic  
Stainless steel jingles  
**FEATURES** Stainless steel jingles for a bright, full sound  
Adjustable mounting system fits perfectly against your heel  
Great accessory for hands-free playing

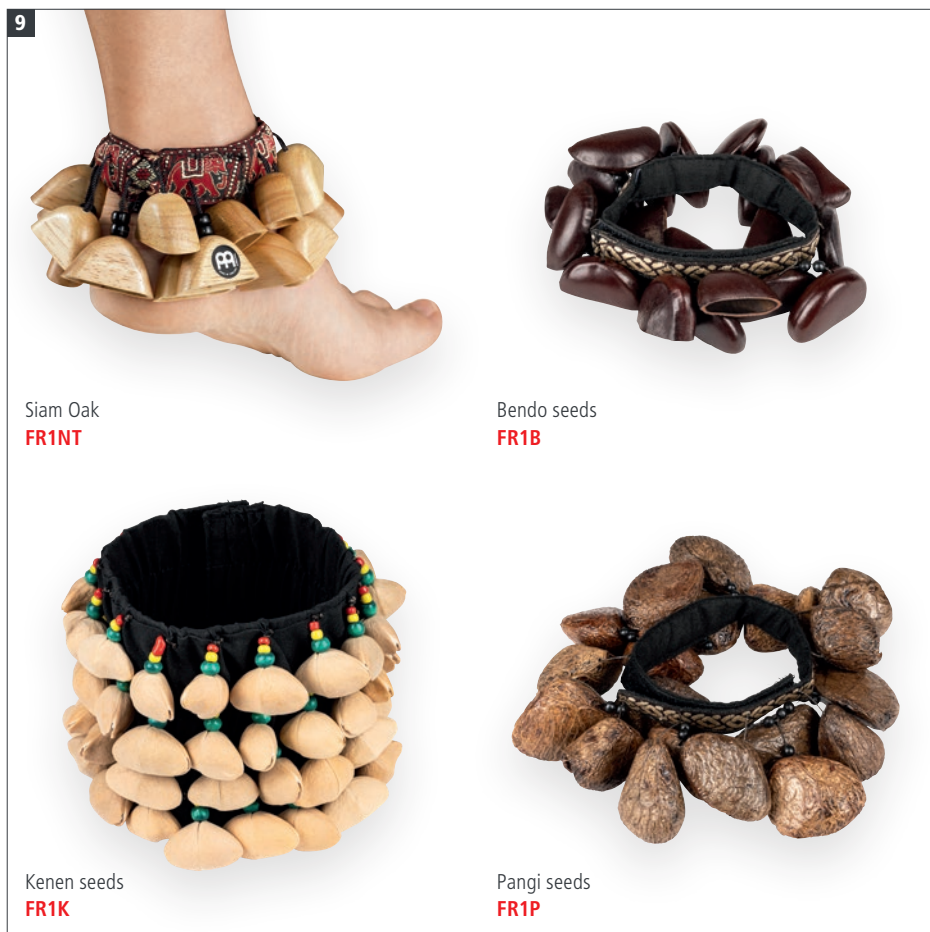

**8 HEEL SHAKER**  
**MATERIAL** Synthetic  
**FEATURES** Great accessory for hands-free playing  
 Shoehorn design fits comfortably against your heel

**9 FOOT RATTLES**  
**MATERIALS** **FR1NT:** Siam Oak (Hevea brasiliensis Muell.-Arg.)  
**FR1B:** Bendo seed nutshells  
**FR1K:** Kenen seed nutshells  
**FR1P:** Pangi seed nutshells  
**FEATURES** Hands-free – straps securely and comfortably around your ankle  
 Creates a hollow wooden shaker effect with warmth and depth  
 Equipped with hook-and-loop strap for a universally adjustable fit

**10 FOOT CABASA (PATENTED)**  
**SIZE** Large  
**MATERIALS** Steel chain and stainless steel cylinder  
 Wooden body  
 Black powder coated pedal  
**FEATURES** Optional single or double-stroke setting  
 5 sound ports on each side for more volume  
**INCLUDES** Drum key  
 Foot pedal

**11 TAMBOURINE HOLDER SET**  
**MATERIAL** Baltic Birch (*Betula pendula*)  
**CONTAINS** Tambourine Holder  
 Headliner® Series Hand Held ABS  
 Tambourine (HTBK)  
**FEATURE** Perfect for cajon players, guitarists and singers

# DJEMBES





The djembe is a powerful and expressive hand drum with origins in West African culture, known for its rich tonal range and deep cultural significance. Crafted traditionally from wood and goat skin, this versatile instrument can produce booming bass, sharp slaps, and resonant tones, making it perfect for dynamic performances and drum circles. Whether you're playing traditional African rhythms or blending it into modern music, the djembe's voice adds an authentic, earthy energy. Easy to play yet full of depth, the djembe is a must-have for percussionists seeking to connect with rhythmic roots and global traditions.

# ROPE TUNED TRAVEL & JR. DJEMBES

1

GALACTIC BLUE TIE DYE



12" PADJ8-L-F  
10" PADJ8-M-F

DAY OF THE DEAD



12" PADJ7-L-F  
10" PADJ7-M-F

KANGA SARONG



12" PADJ6-L-F  
10" PADJ6-M-F

SYNTHETIC HEAD



SIMBRA



12" PADJ5-L-F  
10" PADJ5-M-F

SYNTHETIC HEAD



PHARAOH'S SCRIPT



14" PADJ1-XL-F  
12" PADJ1-L-F  
10" PADJ1-M-F  
8" PADJ1-S-F

SYNTHETIC HEAD



KENYAN QUILT



14" PADJ2-XL-F  
12" PADJ2-L-F  
10" PADJ2-M-F  
8" PADJ2-S-F

## 1 ROPE TUNED TRAVEL SERIES DJEMBES, SYNTHETIC HEAD (PATENTED)

- SIZES**
- S:** 8" diameter, 16" tall
  - M:** 10" diameter, 20" tall
  - L:** 12" diameter, 24" tall
  - XL:** 14" diameter, 26" tall
- HTP ROPES**
- S:** 4 mm thickness, 20 runners
  - M:** 4 mm thickness, 25 runners
  - L:** 4 mm thickness, 30 runners
  - XL:** 5 mm thickness, 35 runners

**MATERIALS** Synthetic shell; Synthetic head

**FEATURES** 100% synthetic heads and shells are perfect for outdoor playing; Ultra light weight makes them easy to carry; Pre-stretched HTP nylon ropes; Produces sharp slaps and deep bass tones; Non-slip rubber bottom to protect the drum from scratches

- FINISHES**
- PADJ1:** Pharaoh's Script
  - PADJ2:** Kenyan Quilt
  - PADJ5:** Simbra
  - PADJ6:** Kanga Sarong
  - PADJ7:** Day of the Dead
  - PADJ8:** Galactic Blue Tie Dye





SYNTHETIC DJEMBES



**2 JR. DJEMBES**

**SIZE** 7" diameter, 12 1/2" tall  
**ROPE** 14 runners  
**MATERIALS** Synthetic shell; Synthetic head  
**FEATURES** Grab-and-go for any occasion, indoors or outside; Compact size and lightweight shell; Pre-stretched ropes; Produces sharp slaps and deep bass tones; 100% synthetic head and shell are perfect for outdoor playing  
**COLOURS** **B:** Blue  
**BK:** Black  
**G:** Green  
**O:** Orange  
**R:** Red  
**Y:** Yellow

**FINISHES** **GB:** Galactic Blue Tie Dye  
**KQ:** Kenyan Quilt  
**PS:** Pharaoh's Script  
**SI:** Simbra  
**TA:** Twisted Amber  
**TD:** Tie Dye

**3 ROPE TUNED TRAVEL SERIES DJEMBES, GOATSKIN HEAD (PATENTED)**

**SIZES** **S:** 8" diameter, 16" tall  
**M:** 10" diameter, 20" tall  
**L:** 12" diameter, 24" tall  
**XL:** 14" diameter, 26" tall  
**HTP ROPES** **S:** 4 mm thickness, 20 runners  
**M:** 4 mm thickness, 25 runners  
**L:** 4 mm thickness, 30 runners  
**XL:** 5 mm thickness, 35 runners

**MATERIALS** Synthetic shell  
**PADJ1, PADJ2** Hand selected goatskin head  
**PADJ4** Black coloured hand selected goatskin head  
**FEATURES** Goatskin heads give you authentic sound and feel; Synthetic shells are perfect for outdoor playing; Ultra light weight makes them easy to carry; Pre-stretched HTP nylon ropes; Produces sharp slaps and deep bass tones; Non-slip rubber bottom to protect the drum from scratches  
**FINISHES** **PADJ1:** Pharaoh's Script  
**PADJ2:** Kenyan Quilt  
**PADJ4:** Phantom Black

# JUMBO DJEMBES

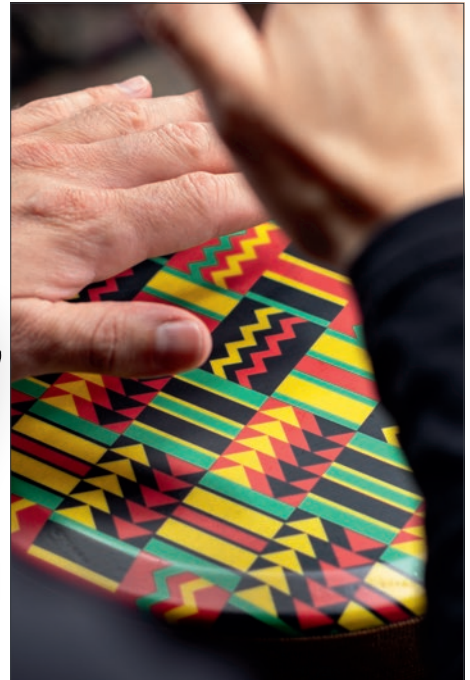

## 1 JUMBO DJEMBES

**SIZES** **JD10:** 10" diameter, 20 1/2" tall  
**JD12:** 12" diameter, 24" tall  
**JD14:** 14" diameter, 26" tall

**MATERIALS** Synthetic shell  
 Synthetic head

**FEATURES** Jumbo size for deep bass tone  
 100% all-weather synthetic shell and head  
 Easy to use mechanical tuning system  
 Lightweight construction to travel easily

**FINISHES** **BW:** Barnwood  
**DA:** Day of the Dead  
**DA-DH:** Day of the Dead, designer head  
**SI:** Simbra  
**SI-DH:** Simbra, designer head

## 2 JUMBO DJEMBE SYNTHETIC HEADS

**SIZES** **HEAD-JD10:** 10"  
**HEAD-JD12:** 12"  
**HEAD-JD14:** 14"

**MATERIALS** Synthetic head

**FEATURES** For the Meinl Jumbo Djembe  
 100% synthetic all-weather head

**FINISHES** **BK:** Black leather cloth  
**DA:** Day of the Dead  
**SI:** Simbra  
**WH:** White Fiberskin  
**Y:** Yellow Fiberskin

## 3 COMMUNITY CONGAS

**SIZES** **TU10SI:** 10" diameter, 25 1/2" tall  
**TU12SI:** 12" diameter, 25 1/2" tall  
**TU14SI:** 14" diameter, 25 1/2" tall

**MATERIALS** Synthetic shell  
 Synthetic head

**FEATURES** Great for drum circles and students  
 Warm open tones  
 Indoor/outdoor  
 Easy to play and tune

**FINISH** **SI:** Simbra

# COMMUNITY DRUMS



**2**

10" HEAD-JD10WH    10" HEAD-JD10Y    10" HEAD-JD10DA    10" HEAD-JD10SI    10" HEAD-JD10BK

12" HEAD-JD12WH    12" HEAD-JD12Y    12" HEAD-JD12DA    12" HEAD-JD12SI    12" HEAD-JD12BK

14" HEAD-JD14WH    14" HEAD-JD14Y    14" HEAD-JD14DA    14" HEAD-JD14SI    14" HEAD-JD14BK

**3**

**SIMBRA**

14" TU14SI    12" TU12SI    10" TU10SI

**DJEMBS & COMMUNITY DRUMS**

**4**

**SIMBRA**

12" TI12SI

**5**

**SIMBRA**

14" TIM14SI

**6**

STACKABLE FOR EASY STORAGE AND TRANSPORTATION

CAN BE TAKEN OFF THE DRUM INSTANTLY WITHOUT ANY TUNING

**BOOM SERIES**

Set, 2 pcs. VR-SDSET-SH

**SOFT SOUND SERIES**

Set, 2 pcs. VR-SDSET-NH

**4 COMMUNITY TIMBAU**

**SIZE** 12" diameter, 23 1/2" tall  
**MATERIALS** Synthetic shell  
 Synthetic head  
**FEATURES** Great for drum circles and students  
 Warm open tones  
 Indoor/outdoor  
 Easy to play and tune  
**FINISH** **SI:** Simbra

**5 COMMUNITY TIMBA**

**SIZE** 14" diameter, 39 1/2" tall  
**MATERIALS** Synthetic shell  
 Synthetic head  
**FEATURES** Great for drum circles and students  
 Warm open tones  
 Indoor/outdoor  
 Easy to play and tune  
**FINISH** **SI:** Simbra

**6 STACK DRUM SETS**

**SIZES** 9 1/2" diameter, 17 1/4" tall  
 12" diameter, 24" tall  
**MATERIALS** Synthetic shell  
**SH:** Synthetic head  
**NH:** Napa head  
**FEATURES** Synthetic shell is perfect for outdoor playing; Stackable for easy storage and transportation; Non-slip rubber bottom; Great for any skill level or style  
**SH:** Pre-tuned synthetic head for cutting sounds with sharp attack  
**NH:** Pre-tuned Napa head creates softer, warmer sound

# ALPINE DJEMBES



## 1 ALPINE SERIES DJEMBES

- SIZES** **ADJ10:** 10" diameter, 20" tall  
**ADJ12:** 12" diameter, 24" tall
- MATERIALS** Synthetic shell  
Synthetic head
- FEATURES** Durable, synthetic head and shell  
Ultra light weight  
Mechanical tuning system  
Perfect for travel and outdoor performance
- FINISHES** **BW:** Barnwood  
**DA:** Day of the Dead  
**GB:** Galactic Blue Tie Dye  
**KA:** Kanga Sarong  
**SI:** Simbra

## 2 PICKUP ALPINE SERIES DJEMBE

- SIZE** 12" diameter, 24" tall
- MATERIALS** Synthetic shell  
Synthetic head
- FEATURES** 100% synthetic djembe; Piezo pickup and volume control; Mechanically tuned head; Great for outdoor performances
- FINISH** **BW:** Barnwood



# POP OFF & 3-IN-1 DJEMBES



**3**

MAY BE PLAYED BY THEMSELVES AS A SMALL HAND DRUM

14" 12" 10" 9" 8" 14" 12" 10" 9" 8"

VR-POH14-SH VR-POH12-SH VR-POH10-SH VR-POH9-SH VR-POH8-SH VR-POH14-NH VR-POH12-NH VR-POH10-NH VR-POH9-NH VR-POH8-NH

**4**

**BOOM SERIES**

CAN BE TAKEN OFF THE DRUM INSTANTLY WITHOUT ANY TUNING

14" x 26 1/4" VR-SDJPO14-SH 12" x 23" VR-SDJPO12-SH 10" x 19 1/2" VR-SDJPO10-SH 9" x 16 1/2" VR-SDJPO9-SH 8" x 16 1/4" VR-SDJPO8-SH

**SOFT SOUND SERIES**

14" x 26 1/4" VR-SDJPO14-NH 12" x 23" VR-SDJPO12-NH 10" x 19 1/2" VR-SDJPO10-NH 9" x 16 1/2" VR-SDJPO9-NH 8" x 16 1/4" VR-SDJPO8-NH

**5**

**BOOM SERIES**

Set, 3 pcs. VR-SDJSET-SH

THE POP OFF DJEMBE HEADS MAY BE PLAYED BY THEMSELVES AS A SMALL HAND DRUM

**SOFT SOUND SERIES**

Set, 3 pcs. VR-SDJSET-NH

STACKABLE FOR EASY STORAGE AND TRANSPORTATION

### 3 POP OFF HEADS

**SIZES** VR-POH8: 8" head diameter  
VR-POH9: 9" head diameter  
VR-POH10: 10" head diameter  
VR-POH12: 12" head diameter  
VR-POH14: 14" head diameter

**MATERIALS** SH: Synthetic head  
NH: Napa head

**FEATURES** Available as Napa style (soft sound) or standard synthetic (sharp sounds)  
Instantly take on or off your Meinl Pop Off Djembe  
May be played by themselves as a small hand drum  
Nylon-loop for easy removal  
Pre-tuned

### 4 POP OFF DJEMBES

**SIZES** VR-SDJPO8: 8" head diameter, 16 1/4" height  
VR-SDJPO9: 9" head diameter, 16 1/2" height  
VR-SDJPO10: 10" head diameter, 19 1/2" height  
VR-SDJPO12: 12" head diameter, 23" height  
VR-SDJPO14: 14" head diameter, 26 1/4" height

**MATERIALS** Synthetic shell  
SH: Synthetic head  
NH: Napa head

**FEATURES** Synthetic shell is perfect for outdoor playing  
Non-slip rubber bottom  
Great for any skill level or style  
SH: Removable, pre-tuned synthetic head for cutting sounds with sharp attack

NH: Removable, pre-tuned Napa head creates softer, warmer sound

### 5 3-IN-1 DJEMBES

**SIZES** 8" head diameter, 16 1/4" height  
10" head diameter, 19 1/2" height  
12" head diameter, 23" height

**MATERIALS** Synthetic shell  
SH: Synthetic head  
NH: Napa head

**FEATURES** Synthetic shell is perfect for outdoor playing  
Non-slip rubber bottom  
Great for any skill level or style  
Stackable for easy storage and transportation  
SH: Pre-tuned synthetic head for cutting sounds with sharp attack  
NH: Pre-tuned Napa head creates softer, warmer sound

SYNTHETIC DJEMBES

# ROPE TUNED HEADLINER® WOOD DJEMBES

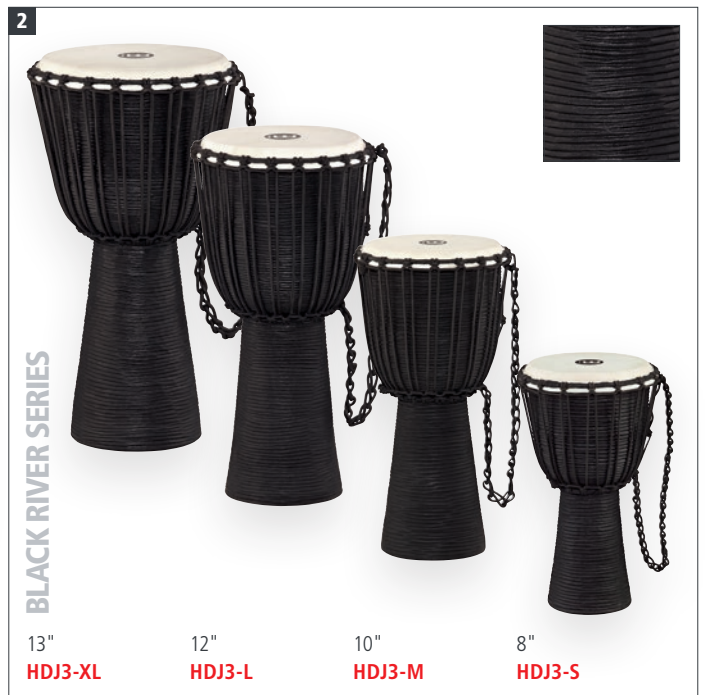

## ROPE TUNED HEADLINER® SERIES

### WOOD DJEMBES 1 2 3 4

- SIZES**
- S:** 8" diameter, 15 3/4" tall
  - M:** 10" diameter, 20" tall
  - L:** 12" diameter, 24" tall
  - XL:** 13" diameter, 25" tall
- PP ROPES**
- S:** 4 mm thickness, 16 runners
  - M:** 4 mm thickness, 18 runners
  - L:** 5 mm thickness, 20 runners
  - XL:** 6 mm thickness, 24 runners

#### 1 NILE SERIES

- MATERIALS** Mahogany Wood (*Swietenia macrophylla*)  
Hand selected goatskin heads
- FEATURES** Carved from one solid piece of plantation grown Mahogany Wood  
Pre-stretched PP nylon ropes  
Hand carved shells
- COLOUR** Brown

#### 2 BLACK RIVER SERIES

- MATERIALS** Mahogany Wood (*Swietenia macrophylla*)  
Hand selected goatskin heads
- FEATURES** Carved from one solid piece of plantation grown Mahogany Wood  
Pre-stretched PP nylon ropes  
Hand carved shells
- COLOUR** Black

#### 3 ARTIFACT SERIES

- MATERIALS** Mahogany Wood (*Swietenia macrophylla*)  
Hand selected goatskin heads
- FEATURES** Carved from one solid piece of plantation grown Mahogany Wood  
Pre-stretched PP nylon ropes  
Hand carved shells
- COLOUR** Brown

#### 4 CONGO SERIES

- MATERIALS** Mahogany Wood (*Swietenia macrophylla*)  
Hand selected goatskin heads
- FEATURES** Carved from one solid piece of plantation grown Mahogany Wood  
Pre-stretched PP nylon ropes  
Hand carved shells  
Ornamental carving
- COLOUR** Dark Brown

# MINI & ROPE TUNED WOOD DJEMBES



**5**

Python Design, 4 1/2"  
**HDJ5-XXS**

Dark Serpent Design, 4 1/2"  
**HDJ6-XXS**

Gecko Design, 4 1/2"  
**HDJ7-XXS**

Flower Design, 4 1/2"  
**HDJ8-XXS**

**6**

BLACK COLOURED HAND SELECTED GOATSKIN HEADS

**FIRE RHYTHM SERIES**

13"  
**ADJ7-XL**

12"  
**ADJ7-L**

10"  
**ADJ7-M**

**EARTH RHYTHM SERIES**

13", bundle with bag  
**ADJ3-XL+BAG**

12", bundle with bag  
**ADJ3-L+BAG**

10", bundle with bag  
**ADJ3-M+BAG**

**WATER RHYTHM SERIES**

13", bundle with bag  
**ADJ2-XL+BAG**

12", bundle with bag  
**ADJ2-L+BAG**

10", bundle with bag  
**ADJ2-M+BAG**

WOOD DJEMBES

**5 AFRICAN STYLE MINI DJEMBES**

**SIZE** 4 1/2" (4 1/4" - 4 3/4") diameter, 8" tall  
**PP ROPE** 3 mm thickness, 10 runners  
**MATERIALS** Mahogany Wood (*Swietenia macrophylla*)  
 Hand selected goatskin head  
**FEATURES** Carved from one solid piece of plantation grown Mahogany Wood  
 High quality PP nylon rope  
 Hand painted shell  
**FINISHES** **HDJ5:** Python Design  
**HDJ6:** Dark Serpent Design  
**HDJ7:** Gecko Design  
**HDJ8:** Flower Design

**6 ORIGINAL AFRICAN STYLE ROPE TUNED WOOD DJEMBES**

**SIZES** **M:** 10" (9 1/4" - 10 1/4") diameter, 20" tall  
**L:** 12" (10 3/4" - 12 1/4") diameter, 24" tall  
**XL:** 13" (12 3/4" - 13 3/4") diameter, 25" tall  
**HTP ROPES** **M:** 4 mm thickness, 25 runners  
**L:** 4 mm thickness, 35 runners  
**XL:** 5 mm thickness, 35 runners  
**MATERIALS** Mahogany Wood (*Swietenia macrophylla*)  
 Hand selected goatskin heads  
**FEATURES** Carved from one solid piece of plantation grown Mahogany Wood  
 Pre-stretched HTP nylon ropes  
 Hand carved shells  
 Ornamental carving  
**ADJ7**  
 Black coloured hand selected goatskin heads  
 Coloured rope wrapping

**INCLUDES** **ADJ2, ADJ3**  
 Professional Djembe Bag made out of heavy-duty padded nylon

**COLOURS** **ADJ2:** Brown  
**ADJ3:** Brown/Black  
**ADJ7:** Black

# PROFESSIONAL, ARTISAN & TONGO CARVED DJEMBES

**1** SPECIAL "AFRICAN QUEEN" CARVING 





12" **PROADJ4-L**      10" **PROADJ4-M**

SPECIAL "VILLAGE" CARVING 



12" **PROADJ2-L**      10" **PROADJ2-M**

**2** DELUXE CARVING 



14" **PROADJ3-XXL**

**3** COLOURED ORNAMENTAL CARVING 



12" **AE-DJTC2-L**

**4** 

**KES-01**



**5** 

**DJTH**



**STANDARD DJEMBE BAGS (SEE PAGE 127)**



**MSTDJB10**      **MSTDJB12**

**1 PROFESSIONAL AFRICAN STYLE DJEMBES**  
**SIZES** **M:** 10" (9 1/4" - 10 1/4") diameter, 20" tall  
**L:** 12" (10 3/4" - 12 1/4") diameter, 24" tall  
**HTP ROPES** **M:** 4 mm thickness, 25 runners  
**L:** 4 mm thickness, 35 runners  
**MATERIALS** Mahogany Wood (*Swietenia macrophylla*)  
 Hand selected goatskin heads  
**FEATURES** Carved from one solid piece of plantation grown Mahogany Wood;  
 Pre-stretched HTP nylon ropes  
**PROADJ2:** "Village" carving  
**PROADJ4:** "African Queen" carving  
**COLOUR** Brown

**2 ARTISAN EDITION DJEMBE**  
**SIZE** 14" (13 3/4" - 15 1/4") diameter, 26" tall  
**HTP ROPE** 5 mm thickness, 40 runners  
**MATERIALS** Mahogany Wood (*Swietenia macrophylla*)  
 Hand selected goatskin head

**FEATURES** Carved from one solid piece of plantation grown Mahogany Wood; Pre-stretched HTP nylon rope; Deluxe carving  
**COLOUR** Brown

**3 ARTISAN EDITION TONGO CARVED DJEMBE**  
**SIZE** 12" (10 3/4" - 12 1/4") diameter, 24" tall  
**HTP ROPE** 5 mm thickness, 30 runners  
**MATERIALS** Mahogany Wood (*Swietenia macrophylla*)  
 Hand selected goatskin head  
**FEATURES** Carved from one solid piece of plantation grown Mahogany Wood; Pre-stretched HTP nylon ropes; Hand carved shell; Coloured ornamental carving  
**COLOUR** Brown

**4 KESSING**  
**SIZE** Medium  
**MATERIAL** Aluminum

**FEATURES** Provides a dry rattling accompaniment to the drum; Slides securely into the webbing and is removable

**5 DJEMBE TUNING HAMMER**  
**MATERIAL** Baltic Birch (*Betula pendula*)  
**FEATURES** Use to tighten the tension on rope tuned djembes; Great for on-the-spot tuning adjustments

**6 HEADLINER® SERIES WOOD DJEMBES**  
**SIZE** 12 1/2" diameter, 25 1/4" tall  
**MATERIALS** Siam Oak (*Hevea brasiliensis* Muell.-Arg.)  
 Hand selected goatskin head  
**FEATURES** 8 mm strong tuning lugs; 2.6 mm rounded rims; Original Meinl style tuning brackets; Black powder coated hardware; Sleek Hourglass shape for more comfort  
**INCLUDES** Tuning key



# HEADLINER® & FLOATUNE WOOD DJEMBES



WOOD DJEMBES

**6 ORIGINAL MEINL STYLE TUNING BRACKETS**

Vintage Wine Barrel, 12 1/2"  
**HDJ500VWB-M**

Natural, 12 1/2"  
**HDJ500NT**

**7 FLOATUNE TUNING AVOIDS THE NEED TO DRILL THROUGH THE SHELL**

Gold Amber Sunburst, 12"  
**DJW3GAB-M**

Natural, 12"  
**DJW3NT**

**8 FLOATUNE TUNING SYSTEM**

Zebra Finished Ash, 12"  
**DJW3ZFA-M**

**9 DESIGNER DJEMBE STRAPS**

Day of the Dead **MDJS1DA**    Kanga Sarong **MDJS1KA**    Kenyan Quilt **MDJS1KQ**    Pharaoh's Script **MDJS1PS**    Simbra **MDJS1SI**

**10 PROFESSIONAL SHOULDER STRAP**

**MDJS2**

**COLOURS** **NT:** Natural, high gloss  
**VWB-M:** Vintage Wine Barrel, matte

**7 FLOATUNE SERIES WOOD DJEMBES**  
**SIZE** 12" diameter, 24 1/4" tall  
**MATERIALS** Siam Oak (*Hevea brasiliensis* Muell.-Arg.)  
 True Skin Goat Head  
**FEATURES** 8 mm strong tuning lugs; 3 mm rounded SSR-Rims; Easy tuning and comfortable change of heads; Rubber pads and lug placement offer perfect playing comfort; Floatune Tuning System; Chrome plated hardware  
**INCLUDES** Accessory pouch  
 L-shaped tuning key  
 Tune Up Oil  
**COLOURS** **GAB-M:** Gold Amber Sunburst, matte  
**NT:** Natural, high gloss

**8 FLOATUNE SERIES WOODCRAFT DJEMBE**  
**SIZE** 12" diameter, 24 1/4" tall  
**MATERIALS** American White Ash (*Fraxinus americana* L.)  
 True Skin Goat Head  
**FEATURES** 8 mm strong tuning lugs; 3 mm rounded SSR-Rims; Easy tuning and comfortable change of heads; Rubber pads and lug placement offer perfect playing comfort; Floatune Tuning System; Chrome plated hardware  
**INCLUDES** Accessory pouch  
 L-shaped tuning key  
 Tune Up Oil  
**COLOUR** Zebra Finished Ash, matte

**9 DESIGNER DJEMBE STRAPS**  
**MATERIAL** Heavy-duty nylon  
**FEATURES** Holds your djembe in a secure playing position; For standing djembe players; Heavy-duty synthetic fabric that lasts; Adjustable webbed PP straps for a comfortable fit  
**COLOURS** **DA:** Day of the Dead  
**KA:** Kanga Sarong  
**KQ:** Kenyan Quilt  
**PS:** Pharaoh's Script  
**SI:** Simbra

**10 PROFESSIONAL SHOULDER STRAP**  
**MATERIAL** Heavy-duty nylon  
**FEATURES** Holds any djembe or other drums in perfect playing position; Length adjustable; Adjustable shoulder padding; Quick change hook  
**COLOUR** Black

# TAMBOURINES FRAME DRUMS

Tambourines and frame drums are timeless percussion instruments found in cultures around the world, known for their simplicity and expressive sound. The tambourine, with its jingling metal zills, adds a bright, rhythmic shimmer to any musical ensemble, while the frame drum, often featuring a single drumhead, produces deep, resonant tones. Both instruments are incredibly versatile, used in everything from folk and classical music to contemporary styles. Whether you're looking to add a rhythmic accent or a rich, earthy foundation, tambourines and frame drums offer dynamic, hand-played percussion for musicians of all levels.





# COMPACT WOOD TAMBOURINES

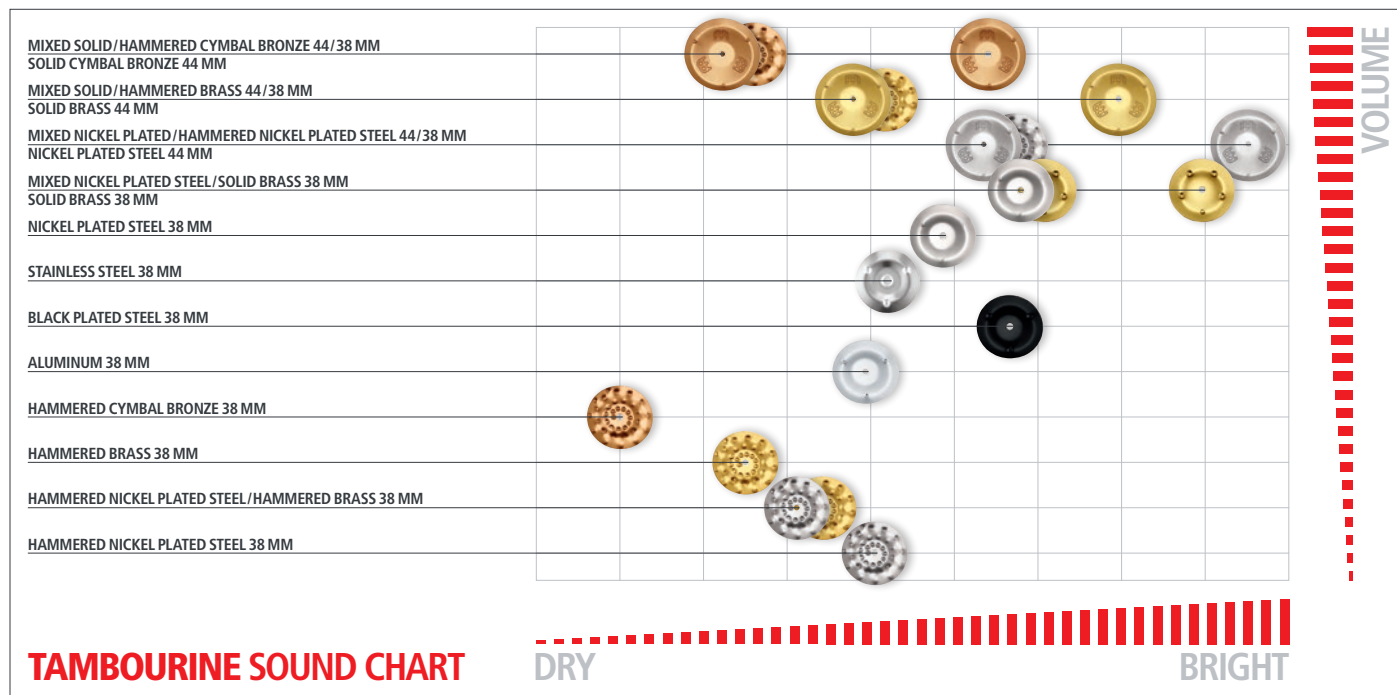

<p><b>1</b></p>  <p>3 rows <b>AE-CMTA3BO</b></p> <p>HAMMERED CYMBAL BRONZE</p>	<p><b>2</b></p>  <p>2 rows <b>CTA2B-BK</b></p> <p>SOLID BRASS</p>	 <p>2 rows <b>CTA2M-BK</b></p> <p>MIXED NICKEL PLATED STEEL / SOLID BRASS</p>	 <p>2 rows <b>CTA2S-BK</b></p> <p>NICKEL PLATED STEEL</p>
 <p>3 rows <b>AE-CMTA3B</b></p> <p>HAMMERED BRASS</p>	 <p>3 rows <b>AE-CATA3S</b></p> <p>HAMMERED NICKEL PLATED STEEL</p>	 <p>2 rows <b>CTA2VM-WB</b></p> <p>MIXED HAMMERED NICKEL PLATED STEEL / BRASS</p>	 <p>2 rows <b>CTA2WB</b></p> <p>STAINLESS STEEL</p>

## 1 ARTISAN EDITION COMPACT TAMBOURINES

**SIZE** 8"

**MATERIALS** **AE-CATA3:** American White Ash (*Fraxinus americana* L.)  
**AE-CMTA3:** Maple (*Adcer* sp.)  
**B:** Hammered brass jingles  
**BO:** Hammered cymbal bronze jingles  
**S:** Hammered nickel plated steel jingles

**FEATURES** Total unique tambourine sounds; Resounding jingle accents; Special profile jingles; Ergonomic hand grip; Detailed with ornamental heat-branded logo; 3 rows of hammered jingles; Extra narrow jingle slots for precise playing

## 2 COMPACT WOOD TAMBOURINES

**SIZE** 8"

**MATERIALS** Wooden frame  
**CTA2B-BK:** Solid brass jingles  
**CTA2M-BK:** Nickel plated steel / solid brass jingles  
**CTA2S-BK:** Nickel plated steel jingles  
**CTA2VM-WB:** Hammered nickel plated steel / hammered brass jingles  
**CTA2WB:** Stainless steel jingles

**FEATURES** Compact size; 2 row version

**COLOURS** **BK:** Black  
**WB:** Walnut Brown

## 3 ARTISAN EDITION TAMBOURINES

**SIZE** 10"

**MATERIALS** **AE-ATA:** American White Ash (*Fraxinus americana* L.)  
**AE-MTA:** Maple (*Adcer* sp.)  
**B:** Solid brass jingles  
**BO:** Solid cymbal bronze jingles  
**S:** Nickel plated steel jingles

**FEATURES** Total unique tambourine sounds; Resounding tambourine accents; Special profile jingles; Ergonomic hand grip; Detailed with ornamental heat-branded logo; 1 row and 2 row version

# WOOD TAMBOURINES



TAMBOURINES

**3**

1 row  
**AE-MTA1B0**

2 rows  
**AE-MTA2B0**

SOLID CYMBAL  
BRONZE 44 MM

1 row  
**AE-MTA1B**

2 rows  
**AE-MTA2B**

SOLID BRASS 44 MM

1 row  
**AE-ATA1S**

2 rows  
**AE-ATA2S**

NICKEL PLATED  
STEEL 44 MM

**4**

1 row  
**TA1V-WB**

2 rows  
**TA2V-WB**

HAMMERED BRASS

1 row  
**TA1B-AB**

2 rows  
**TA2B-AB**

SOLID BRASS

1 row  
**TA1AB**

2 rows  
**TA2AB**

NICKEL  
PLATED STEEL

1 row  
**TA1VM-WB**

2 rows  
**TA2VM-WB**

MIXED  
HAMMERED NICKEL  
PLATED STEEL / BRASS

1 row  
**TA1WB**

2 rows  
**TA2WB**

STAINLESS STEEL

1 row  
**TA1A-AB**

2 rows  
**TA2A-AB**

ALUMINUM

**6**

1 row  
**TA1M-SNT**

2 rows  
**TA2M-SNT**

MIXED  
NICKEL PLATED  
STEEL / SOLID BRASS

**7**

2 rows  
**VR-TA2-ROM**

## 4 VINTAGE WOOD TAMBOURINES

SIZE 10"  
 MATERIALS Wooden frame  
**TA1V:** Hammered brass jingles  
**TA1VM:** Hammered nickel plated steel / hammered brass jingles  
 FEATURES Legendary tambourine sound; Special profile jingles; Detailed with heat-branded logo; 1 row and 2 row version  
 COLOUR **WB:** Walnut Brown

## 5 TRADITIONAL WOOD TAMBOURINES

SIZE 10"  
 MATERIALS Wooden frame  
**TA1A-AB, TA2A-AB:** Aluminum jingles  
**TA1B-AB, TA2B-AB:** Solid brass jingles  
**TA1AB, TA2AB:** Nickel plated steel jingles  
**TA1WB, TA2WB:** Stainless steel jingles  
 FEATURES 1 row and 2 row version  
**TA1WB, TA2WB:** Detailed with heat-branded logo  
 COLOURS **AB:** Antique Brown  
**WB:** Walnut Brown

## 6 RECORDING-COMBO WOOD TAMBOURINES

SIZE 10"  
 MATERIALS Wooden frame  
 Nickel plated steel / solid brass jingles  
 FEATURES Dual-alloy jingles; 1 row and 2 row version  
 COLOUR **SNT:** Super Natural

## 7 WOOD TAMBOURINE

SIZE 10"  
 MATERIALS Black plated steel jingles  
 Siam Oak (*Hevea brasiliensis* Muell.-Arg.)  
 FEATURES Double row; Ergonomic grip  
 FINISH Red/orange marble

# HEADED WOOD TAMBOURINES



## 1 HEADED ARTISAN EDITION TAMBOURINES

**SIZE** 10"

**MATERIALS** Hand selected calfskin heads  
**AE-ATAH:** American White Ash (*Fraxinus americana* L.)  
**AE-MTAH:** Maple (*Adcer sp.*)  
**B:** Solid / hammered brass jingles  
**BO:** Solid / hammered cymbal bronze jingles  
**S:** Nickel plated / hammered nickel plated steel jingles

**FEATURES** Total unique tambourine sounds; Resounding jingle accents; Two different profile jingles; Ergonomic hand grip; Detailed with ornamental heat-branded logo; Prepared with Resin

## 2 TAMBURELLO

**SIZE** 12"

**MATERIALS** Wooden frame; Hand selected goatskin head; Aluminum jingles

**FEATURES** 2 row version; Detailed with heat-branded logo; Total unique tambourine sounds

## 3 VINTAGE GOATSKIN WOOD TAMBOURINES

**SIZE** 10"

**MATERIALS** Wooden frame; Hand selected goatskin heads; Hammered brass jingles

**FEATURES** 1 row and 2 row version; Detailed with heat-branded logo

**COLOUR** **WB:** Walnut Brown

## 4 TOURING SYNTHETIC HEAD WOOD TAMBOURINES

**SIZE** 10"

**MATERIALS** Wooden frame; True Feel synthetic heads; Black plated steel jingles

**FEATURE** 1 row and 2 row version  
**COLOUR** **R:** Red

## 5 RECORDING-COMBO GOATSKIN WOOD TAMBOURINES

**SIZE** 10"

**MATERIALS** Wooden frame; Hand selected goatskin heads; Nickel plated steel / solid brass jingles

**FEATURES** Dual-alloy jingles; 1 row and 2 row version

**COLOUR** **SNT:** Super Natural

## 6 TRADITIONAL GOATSKIN WOOD TAMBOURINES

**SIZE** 10"

**MATERIALS** Wooden frame; Hand selected goatskin heads  
**TAH1A-AB, TAH2A-AB:** Aluminum jingles

# HAND HELD ABS TAMBOURINES



TAMBOURINES

**7**



1 row, 8"  
**HTT8BK**

2 rows, 10"  
**HTT10BK**



1 row, 8"  
**HTT8R**

2 rows, 10"  
**HTT10R**



1 row, 8"  
**HTT8WH**

2 rows, 10"  
**HTT10WH**

STAINLESS STEEL

**8**



1 row  
**HTBK**

2 rows  
**HTMT1BK**



1 row  
**HTR**

2 rows  
**HTMT1R**



1 row  
**HTWH**

2 rows  
**HTMT1WH**

STAINLESS STEEL

**9**



2 rows  
**TMT1B-BK**

SOLID BRASS



2 rows  
**TMT1BK**

NICKEL PLATED STEEL



2 rows  
**TMT1R**

NICKEL PLATED STEEL



2 rows  
**TMT1A-B**

ALUMINUM

**10**



2 rows  
**TMT1M-BK**

MIXED NICKEL PLATED STEEL / SOLID BRASS



2 rows  
**TMT1M-WH**

**TAH1B-AB, TAH2B-AB:**

Solid brass jingles

**TAH1AB, TAH2AB:**

Nickel plated steel jingles

**TAH1WB, TAH2WB:**

Stainless steel jingles

**FEATURES** 1 row and 2 row version

**TAH1WB, TAH2WB:** Detailed with heat-branded logo

**COLOURS** **AB:** Antique Brown

**WB:** Walnut Brown

**7 HEADLINER® SERIES TOUR TAMBOURINES**

**SIZES** **HTT8:** 8"  
**HTT10:** 10"

**MATERIALS** Molded ABS; Stainless steel jingles

**FEATURES** Handheld; Extra wide grip; Bright, cutting sound; Durable frame

**HTT8:** 1 row version; Compact size

**HTT10:** 2 row version

**COLOURS** **BK:** Black  
**R:** Red  
**WH:** White

**8 HEADLINER® SERIES HAND HELD ABS TAMBOURINES**

**MATERIALS** Molded ABS; Stainless steel jingles

**FEATURES** Ergonomic hand grip for more playing comfort; Güiro style playing surface; Penetrating jingle sound

**HT:** 1 row version

**HTMT1:** 2 row version

**COLOURS** **BK:** Black  
**R:** Red  
**WH:** White

**9 TRADITIONAL HAND HELD ABS TAMBOURINES**

**MATERIALS** Molded ABS  
**TMT1A-B:** Aluminum jingles

**TMT1B-BK:** Solid brass jingles

**TMT1BK, TMT1R:** Nickel plated steel jingles

**FEATURES** Padded soft grip for more playing comfort; Ergonomic design; Güiro style playing surface; "Sandwich" construction

**COLOURS** **B:** Blue

**BK:** Black

**R:** Red

**10 RECORDING-COMBO HAND HELD ABS TAMBOURINES**

**MATERIALS** Molded ABS; Nickel plated steel / solid brass jingles

**FEATURES** Padded soft grip for more playing comfort; Ergonomic design; Güiro style playing surface; "Sandwich" construction

**COLOURS** **BK:** Black

**WH:** White

# MOUNTABLE ABS TAMBOURINES

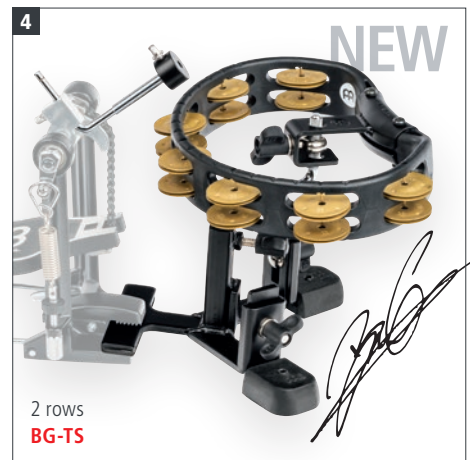
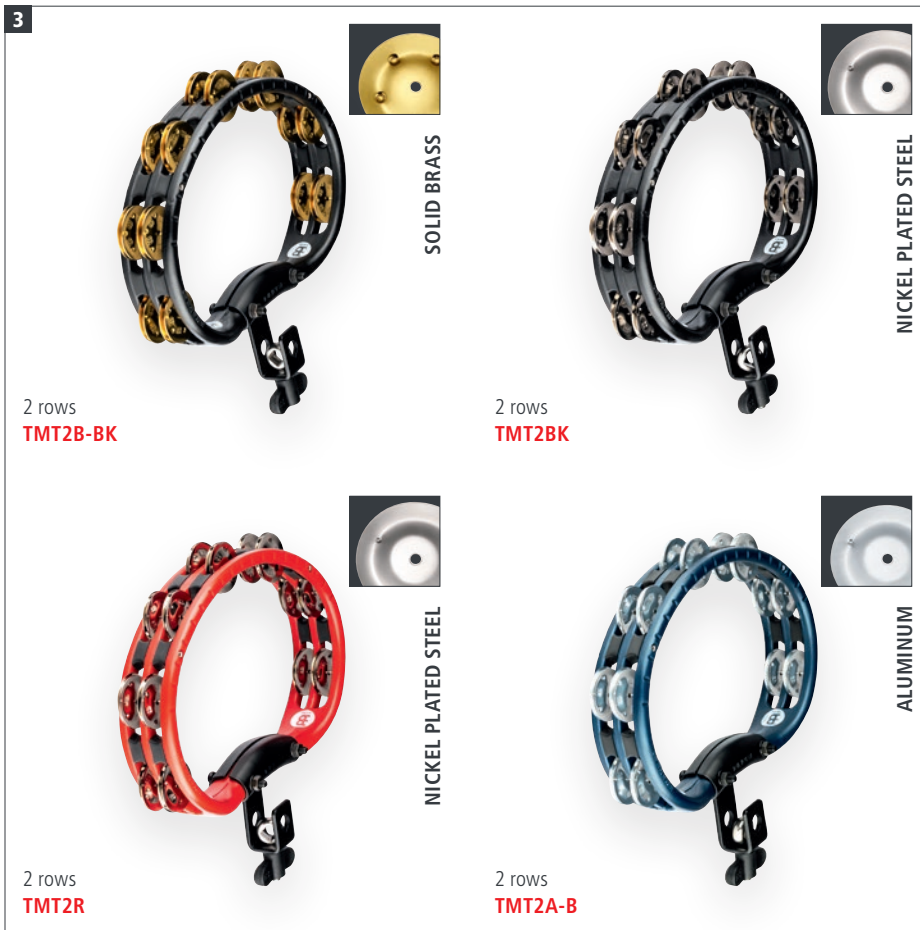
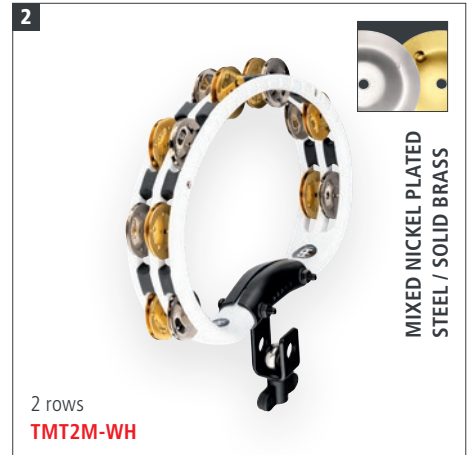

## 1 HEADLINER® SERIES MOUNTABLE ABS TAMBOURINES

- MATERIALS** Molded ABS  
Stainless steel jingles
- FEATURES** Easy mountable  
Güiro style playing surface  
Penetrating jingle sound
- COLOURS** **BK:** Black  
**R:** Red  
**WH:** White

## 2 RECORDING-COMBO MOUNTABLE ABS TAMBOURINE

- MATERIALS** Molded ABS  
Nickel plated steel / solid brass jingles
- FEATURES** Easily mountable  
Ergonomic design  
Güiro style playing surface  
"Sandwich" construction
- COLOUR** **WH:** White

## 3 TRADITIONAL MOUNTABLE ABS TAMBOURINES

- MATERIALS** Molded ABS  
**TMT2A-B:** Aluminum jingles  
**TMT2B-BK:** Solid brass jingles  
**TMT2BK, TMT2R:** Nickel plated steel jingles
- FEATURES** Easily mountable  
Ergonomic design  
Güiro style playing surface  
"Sandwich" construction
- COLOURS** **B:** Blue  
**BK:** Black  
**R:** Red

## 4 BENNY GREB SIGNATURE TAMBOSTEP

- MATERIAL** Sand blasted brass jingles
- FEATURES** Designed with Benny Greb  
Hands-free tambourine  
Great for multi-instrumentalists, guitarists, and cajon players
- INCLUDES** Pedal Mount (PM-1); Special designed Z-shaped rod and beater



# CHING RINGS & HIHAT TAMBOURINES



TAMBOURINES

**1**



Ching Ring  
**CRING**

STAINLESS STEEL



Dry Ching Ring  
**DCRING**

ZINC



Soft Ching Ring  
**SCRING**

STAINLESS STEEL

**2**



**SFHHT**

**3**



1 row  
**HTHH1B-BK**

HAMMERED BRASS



2 rows  
**HTHH2B-BK**

HAMMERED BRASS

**4**



1 row  
**THH1B-BK**

SOLID BRASS



1 row  
**HTHH1BK**

STAINLESS STEEL



1 row  
**THH1BK**

STAINLESS STEEL



2 rows  
**HTHH2BK**

STAINLESS STEEL

**5**



1 row  
**HTHHBG**

SAND HIHAT TAMBOURINE  
DESIGNED WITH BENNY GREB

**6** **NEW**



**TMTH**

STAINLESS STEEL

## 1 CHING RINGS

**SIZE** 6"

**MATERIALS** **CRING**  
Steel ring  
5 pairs of stainless steel jingles

**DCRING**  
Steel ring  
5 pairs of zinc jingles

**SCRING**  
Foam ring  
6 pairs of stainless steel jingles

**FEATURES**  
Fits on most cymbals  
Quick setup

## 2 SUPER FLEX HIHAT TAMBOURINE

**SIZE** 4.3" inner diameter, 9.5" outer diameter

**MATERIALS** Mylar frame  
10 pairs of stainless steel jingles

**FEATURES** Super flex frame produces enhanced hihat tambourine accents

10 pairs of stainless steel jingles deliver a clear and bright sound  
Extra-wide 9.5" shape gives you outstanding foot response  
Shines through the mix to easily blend a tambourine effect into your grooves

## 3 HEADLINER® SERIES HIHAT TAMBOURINES

**SIZE** 5"

**MATERIALS** **HTHH1BK, HTHH2BK:**  
Stainless steel jingles  
**HTHH1B-BK, HTHH2B-BK:**  
Hammered brass jingles

**FEATURE** 1 row and 2 row version

## 4 PROFESSIONAL SERIES HIHAT TAMBOURINES

**SIZE** 5"

**MATERIALS** **THH1BK:** Stainless steel jingles  
**THH1B-BK:** Solid brass jingles

**FEATURE** Rubber padded surface

## 5 BENNY GREB SAND HIHAT TAMBOURINE

**SIZE** 5"

**MATERIAL** Sand blasted brass jingles

**FEATURES** Benny Greb signature hihat tambourine  
Eight pairs of sand blasted brass jingles  
Dry, vintage sound with unique matte appearance  
Blends easily into your natural drum set or percussion mix  
Wing nut design fits on any hihat rod

## 6 TAMBOURINE HIHAT

**SIZE** 5"

**MATERIAL** Stainless steel jingles

**FEATURES** Top and bottom pieces work like hihats  
Great for low volume kits  
Sturdy steel frame

# CRASHERS, BACKBEAT TAMBOURINES & JINGLE STICKS



## 1 TURBO CRASHERS

**SIZES** **CRASHER-M**: Medium  
**CRASHER**: Large

**MATERIAL** Steel

**FEATURES** Güiro style playing surface; Cutting sound; Easy mountable

## 2 BACKBEAT TAMBOURINES

**SIZES** **BBT1-BK**: For 10" and 12" drums  
**BBT2-BK**: For 13" and 14" drums

**MATERIALS** Eco-friendly medium density fiberboard; Stainless steel jingles

**FEATURES** Fits on any standard drum; Adds a tambourine sound to the groove; Hook and loop fastener

**COLOUR** **BK**: Black

## 3 BACKBEAT PRO TAMBOURINE

**SIZE** 14"

**MATERIALS** Cymbal brass alloy ring; Solid brass jingles

**FEATURES** Blackened brass ring made from Meinl Cymbal Alloy; Eight pairs of solid brass jingles

## 4 HEADLINER® SERIES JINGLE STICKS

**MATERIALS** Molded ABS; Stainless steel jingles

**COLOURS** **BK**: Black  
**R**: Red

## 5 PROFESSIONAL SERIES JINGLE STICKS

**MATERIALS** Molded ABS  
**JG1**: Nickel plated steel jingles  
**JG1A**: Aluminum jingles  
**JG1B**: Solid brass jingles  
**JG1M**: Nickel plated steel / solid brass jingles

**FEATURES** Padded grip; Güiro style playing surface

## 6 MULTI-JINGLE STICK

**MATERIALS** Molded ABS; Nickel plated steel / solid brass jingles

**FEATURES** Jingles mounted on two intersecting planes  
Padded grip; Special playing techniques

# ARTISAN EDITION RIQ DRUM & PANDEIROS



**1**

Synthetic head, 8 3/4"  
**AERIQ1**

**2**

CHROME PLATED STEEL JINGLES

Clear Mylar head, 10"  
**PA10ABS-BK**

Napa head, 10"  
**PA10ABS-BK-NH**

**3**

CHROME PLATED STEEL JINGLES

Poplar Wood, 10"  
**PA10PW-M**

Siam Oak, 10"  
**PA10CN-M**

**4**

HAND-HAMMERED BRASS JINGLES

Goatskin head, 10"  
**PA10AB-M**



Siam Oak, 12"  
**PA12CN-M**

**5**

UNIQUE SHAKER PODS

Napa head, 10"  
**PAS10PW-NH**

**6**

EASY MOUNTABLE

Napa head, 10"  
**PA10A-BK-NH-H**

**1 ARTISAN EDITION RIQ DRUM**

**SIZE** 8 3/4"  
**MATERIALS** Wooden frame; Synthetic head; Ten pairs of brass jingles  
**FEATURES** Artisan sounds for Arabic folk and classical music; Five tuning lugs  
**INCLUDES** Tuning key; Bag  
**FINISH** White Pearl Mosaic Royale

**2 TRADITIONAL ABS PANDEIROS**

**SIZE** 10"  
**MATERIALS** Molded ABS; Chrome plated steel jingles  
**PA10ABS-BK**  
Replaceable synthetic head  
**PA10ABS-BK-NH**  
Replaceable Napa head  
**FEATURES** Countersunk bolt lugs  
**PA10ABS-BK:** Logo applied from underneath the head (CN, TH, US patent)  
**PA10ABS-BK-NH:** Reduced overtones

**INCLUDES** Tuning key  
**COLOUR** **BK:** Black

**3 TRADITIONAL WOOD PANDEIROS**

**SIZES** **PA10:** 10"  
**PA12:** 12"  
**MATERIALS** Replaceable hand selected goatskin head; Chrome plated steel jingles  
**PA10CN-M, PA12CN-M**  
Siam Oak (*Hevea brasiliensis* Muell.-Arg.)  
**PA10PW-M**  
Poplar Wood (*Populus*)

**INCLUDES** Tuning key  
**COLOUR** **CN-M:** Chestnut, matte

**4 SHELL-TUNED PANDEIRO**

**SIZE** 10"  
**MATERIALS** Siam Oak (*Hevea brasiliensis* Muell.-Arg.)  
Hand selected goatskin head;  
Hand-hammered brass jingles

**INCLUDES** Hex key  
**COLOUR** **AB-M:** Antique Brown, matte

**5 SHAKER PANDEIRO**

**SIZE** 10"  
**MATERIALS** Poplar Wood (*Populus*); Replaceable Napa head; Aluminum shaker pods  
**FEATURE** Countersunk bolt lugs  
**INCLUDES** Tuning key

**6 TRADITIONAL ABS PANDEIRO WITH HOLDER**

**SIZE** 10"  
**MATERIALS** Molded ABS; Replaceable Napa head; Chrome plated steel jingles  
**FEATURES** Countersunk bolt lugs; Reduced overtones; Easy mountable  
**INCLUDES** Tuning key  
**COLOUR** **BK:** Black

# FRAME DRUMS



**1 HAND DRUMS**

**SIZES** **HD10:** 10"; **HD12:** 12"; **HD14:** 14"; **HD16:** 16"; **HD18:** 18"; **HD20:** 20"; **HD22:** 22"

**MATERIALS** Siam Oak (*Hevea brasiliensis* Muell.-Arg.)  
**AB:** Hand selected goatskin head  
**AB-TF:** True Feel synthetic head

**COLOUR** Antique Brown

**2 TARS**

**SIZES** **FD16:** 16", 2 1/2" deep  
**FD18:** 18", 2 1/2" deep  
**FD20:** 20", 2 1/2" deep  
**FD22:** 22", 2 1/2" deep

**MATERIALS** Siam Oak (*Hevea brasiliensis* Muell.-Arg.)  
**T:** Hand selected goatskin head  
**T-TF:** True Feel synthetic head

**FEATURE** Internal tuning system

**INCLUDES** Hex key

**COLOUR** Antique Brown, matte

**3 ARTISAN EDITION TARS (PATENTED)**

**SIZES** **AE-FD14:** 14", 2 1/2" deep  
**AE-FD18:** 18", 2 1/2" deep  
**AE-FD22:** 22", 2 1/2" deep

**MATERIALS** Siam Oak (*Hevea brasiliensis* Muell.-Arg.)  
Hand selected goatskin head

**FEATURES** Special designed bearing edge (DE, US patent); Internal tuning system

**INCLUDES** Hex key

**COLOUR** Walnut Brown, matte

**4 SEA DRUMS**

**SIZES** **FD16:** 16", 2 3/4" deep  
**FD18:** 18", 2 3/4" deep  
**FD20:** 20", 2 3/4" deep  
**FD22:** 22", 2 3/4" deep

**MATERIALS** Siam Oak (*Hevea brasiliensis* Muell.-Arg.)  
Transparent synthetic head and  
**SD:** Hand selected goatskin head  
**SD-TF:** True Feel synthetic head

**FEATURES** Steel balls inside; Sealable filling port

**COLOUR** Antique Brown, matte

**5 MIZHARS**

**SIZES** **FD12:** 12", 4" deep; **FD14:** 14", 4" deep; **FD18:** 18", 4" deep

**MATERIALS** Siam Oak (*Hevea brasiliensis* Muell.-Arg.)  
**T-D:** Hand selected goatskin head  
**T-D-TF:** True Feel synthetic head

**FEATURES** Deep shell construction for full sound development; Internal tuning system

**INCLUDES** Hex key

**COLOUR** Brown Burl, matte

**6 ARTISAN EDITION MIZHARS (PATENTED)**

**SIZES** **AE-FD14:** 14", 4" deep  
**AE-FD18:** 18", 4" deep  
**AE-FD22:** 22", 4" deep

**MATERIALS** Siam Oak (*Hevea brasiliensis* Muell.-Arg.)  
Hand selected goatskin head

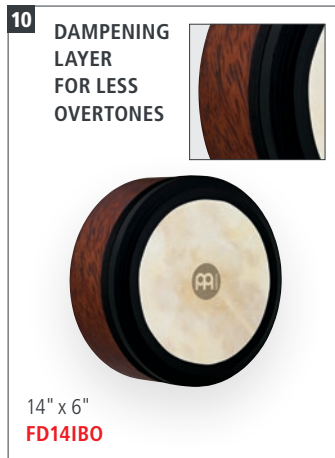
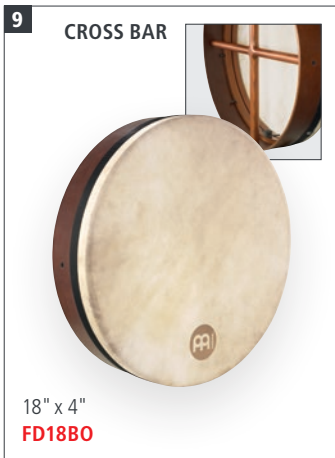

**FEATURES** Special designed bearing edge (DE, US patent); Internal tuning system  
**INCLUDES** Hex key  
**COLOUR** Walnut Brown, matte

### 7 BENDIRS

**SIZES** **FD12:** 12", 4" deep; **FD14:** 14", 4" deep; **FD16:** 16", 2 1/2" deep  
**MATERIALS** Siam Oak (*Hevea brasiliensis* Muell.-Arg.)  
**BE:** Hand selected goatskin head  
**BE-TF:** True Feel synthetic head  
**FEATURES** Internal tuning system; Buzzing effect  
**INCLUDES** Hex key  
**COLOUR** Antique Brown, matte

### 8 DAFS

**SIZE** 20", 2 1/2" deep  
**MATERIALS** Siam Oak (*Hevea brasiliensis* Muell.-Arg.)  
**FD20D-TF:** True Feel synthetic head  
**FD20D-WH:** Woven synthetic head

**FEATURE** Metal rings for special effects  
**COLOUR** Antique Brown, matte

### BODHRANS 9 10

**MATERIALS** Siam Oak (*Hevea brasiliensis* Muell.-Arg.)  
**INCLUDES** Hand selected goatskin head  
**INCLUDES** Hex key

### 9 CELTIC BODHRAN

**SIZE** 18", 4" deep  
**FEATURES** Cross bar; Internal tuning system  
**COLOUR** Antique Brown, matte

### 10 IRISH BODHRAN

**SIZE** 14", 6" deep  
**FEATURES** Extra deep shell for full sound development; Dampening layer around rim for reduced overtones  
**COLOUR** Brown Burl, matte

### 11 KANJIRA

**SIZE** 7 1/2", 2 1/4" deep  
**MATERIALS** Siam Oak (*Hevea brasiliensis* Muell.-Arg.)  
**FEATURES** Hand selected goatskin head  
**INCLUDES** Many sound options; Set of 3 jingles  
**COLOUR** Antique Brown, matte

### 12 NATIVE AMERICAN-STYLE HOOP DRUMS

**SIZES** **HOD125:** 12 1/2"; **HOD15:** 15"  
**MATERIALS** Hand selected buffalo head  
**FEATURE** Nylon lacing and grip  
**INCLUDES** Warm and powerful sound  
**INCLUDES** Leather padded wooden beater

### 13 PLENERA SET

**SIZES** 8" Quinto; 10" Seguidor; 12" Tumbador  
**MATERIALS** ABS molded frames; Goatskin heads  
**FEATURE** External mechanical lug tuning  
**INCLUDES** Nylon Bag; Tuning Key



# HAND PERCUSSION



Hand percussion instruments like shakers, kalimbas, and castanets, chimes and many more instruments bring subtle yet essential rhythms to a wide range of musical styles. These small, easy-to-play instruments offer a delicate and precise way to enhance the groove, adding texture and colour to your sound. From the crisp shake of a maraca to the sharp click of claves, hand percussion creates dynamic layers that enrich both live performances and studio recordings. Whether you're a seasoned percussionist or a beginner, these instruments are perfect for adding a rhythmic pulse and driving the energy of any musical piece.

# SHAKERS & TAMBOURINES

**1**

<p><b>SOFT: STUDIO</b></p>  <p>Studio shaker, Red <b>SH5R</b></p> <p>72 - 76 DB</p>	<p><b>MEDIUM: LIVE</b></p>  <p>Live shaker, Black <b>SH4BK</b></p> <p>79 - 81 DB</p>	<p><b>MEDIUM: LIVE</b></p>  <p>Live shaker, Creamsicle <b>SH4CS</b></p>	<p><b>MEDIUM: LIVE</b></p>  <p>Live shaker, Electric Coral <b>SH4EC</b></p>
<p><b>MEDIUM: LIVE</b></p>  <p>Live shaker, Glacier Blue <b>SH4GB</b></p>	<p><b>MEDIUM: LIVE</b></p>  <p>Live shaker, Seafoam Green <b>SH4SF</b></p>	<p><b>MEDIUM: LIVE</b></p>  <p>Live shaker, White <b>SH4WH</b></p>	<p><b>LOUD: STADIUM</b></p>  <p>Stadium shaker, Grey <b>SH45GR</b></p> <p>88 - 93 DB</p>

**2**



**MSS**

**3**



Set, 3 pcs.  
**PP-1**

**4**



Set, 4 pcs.  
**ES-SET-2**

**5**

**SOFT**

**MEDIUM**

**LOUD**

**EXTRA LOUD**



Set, 4 pcs.  
**ES-SET**

**6**

**Black ES2-BK**

**Red ES2-R**

**Blue ES2-B**

**Yellow ES2-Y**

**Green ES2-GREEN**

**COMES IN A SET OF TWO**



## 1 ARTIST SERIES SHAKERS LUIS CONTE

**SIZE** Medium

**MATERIAL** Synthetic

**FEATURES** Two individual shakers connected as one instrument

**SH4:** Perfect for live playing

**SH45:** Perfect for stadium situations

**SH5:** Perfect for studio recordings

**COLOURS**

**BK:** Black

**CS:** Creamsicle

**EC:** Electric Coral

**GB:** Glacier Blue

**GR:** Grey

**R:** Red

**SF:** Seafoam Green

**WH:** White

## 2 LUIS CONTE SHAKER WITH STRAPS

**SIZE** Medium

**MATERIAL** Synthetic

**FEATURES** Strap to a drumstick to get shaker sounds as you play

Add new sonic layers to your drum set grooves

**COLOUR** **BK:** Black

**INCLUDES** Two durable rubber straps

## 3 PERC PACK

**CONTAINS** Compact Foot Tambourine

Luis Conte Live Shaker

Classic Wood Claves

**FEATURES** Compact Foot Tambourine for hands free use

Luis Conte Live Shaker for smooth sound

Classic Wood Claves for traditional rhythms

## 4 EGG SHAKER ASSORTMENT

**MATERIAL** Synthetic

**FEATURES** Four-piece egg shaker set ideal for any percussion set up

Designed for four different volume levels

Colour coded for easy identification

Easily transportable

## 5 EGG SHAKER SET

**MATERIAL** Synthetic

**FEATURE** Range of volume from soft to extra loud

## 6 EGG SHAKER PAIRS

**MATERIAL** Synthetic

**FEATURE** Comes in a set of two

**COLOURS**

**B:** Blue

**BK:** Black

**GREEN:** Green

**R:** Red

**Y:** Yellow





Set, 24 pcs.  
**ES-SET24-BK**

Set, 24 pcs.  
**ES-SET24-MC**



Set, 60 pcs.  
**ES-BOX**

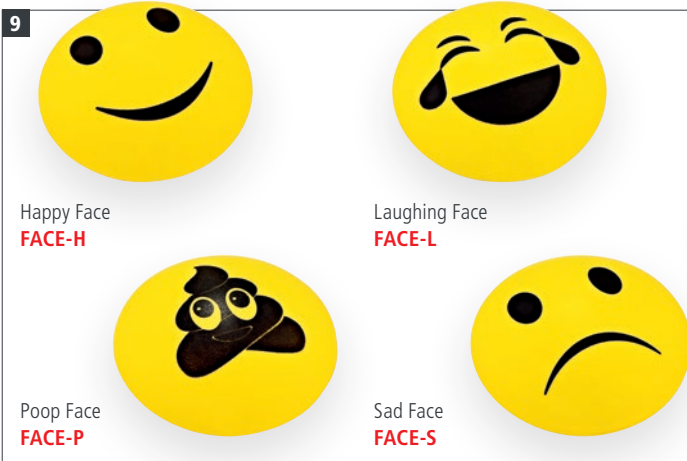

Happy Face  
**FACE-H**

Laughing Face  
**FACE-L**

Poop Face  
**FACE-P**

Sad Face  
**FACE-S**

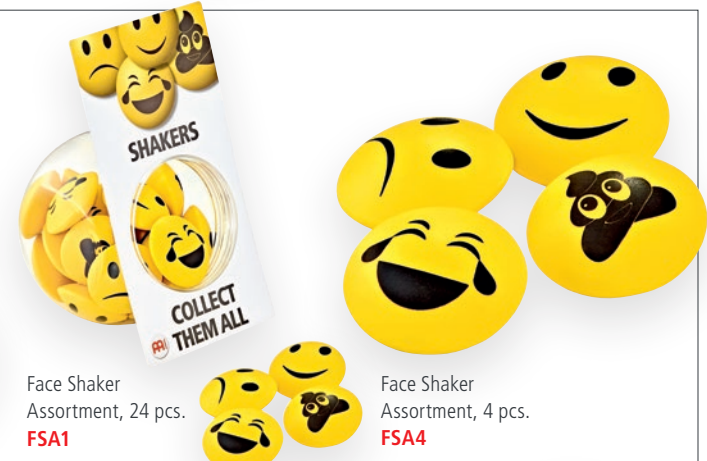

Face Shaker Assortment, 24 pcs.  
**FSA1**

Face Shaker Assortment, 4 pcs.  
**FSA4**



Key Ring Tambourine, Red  
**KRT-R**

Key Ring Tambourine, Black  
**KRT-BK**

Key Ring Shaker and Tambourine Assortment  
**KRA1**

Key Ring Shaker, Grey  
**KRS-GR**

Key Ring Shaker, Black  
**KRS-BK**

### 7 EGG SHAKER SETS OF 24 PCS.

- MATERIAL** Synthetic
- FEATURES** Crystal clear shaker sounds  
Durable shells  
Great for group or classroom percussion
- COLOURS** **BK:** Black  
**MC:** Multi-colour

### 8 EGG SHAKER BOX

- CONTAINS** Holds 60 Egg Shakers:  
20 x Egg Shaker, Blue (B)  
10 x Egg Shaker, Black (BK)  
10 x Egg Shaker, Green (GREEN)  
10 x Egg Shaker, Red (R)  
10 x Egg Shaker, Yellow (Y)

### 9 FACE SHAKERS

- MATERIAL** Molded ABS
- CONTAINS** **FSA1**  
6 x Happy Face  
6 x Laughing Face  
6 x Poop Face  
6 x Sad Face  
**FSA4**  
1 x Happy Face  
1 x Laughing Face  
1 x Poop Face  
1 x Sad Face
- FEATURES** Made of durable molded ABS  
Loud filling projects clearly  
Great accent for live and studio applications
- INCLUDES** **FSA1:** Fishbowl

- GRAPHICS** **FACE-H:** Happy Face  
**FACE-L:** Laughing Face  
**FACE-P:** Poop Face  
**FACE-S:** Sad Face

### 10 KEY RING SHAKERS & KEY RING TAMBOURINES

- MATERIALS** Molded ABS  
**KRT:** Nickel plated steel
- CONTAINS** **KRA1**  
10 x Key Ring Shaker  
8 x Key Ring Tambourine
- FEATURES** Easily detach when it's time to play  
Perfect for acoustic shows or jam sessions
- INCLUDES** **KRA1:** Fishbowl
- FINISHES** **BK:** Black  
**GR:** Grey  
**R:** Red

# SHAKERS

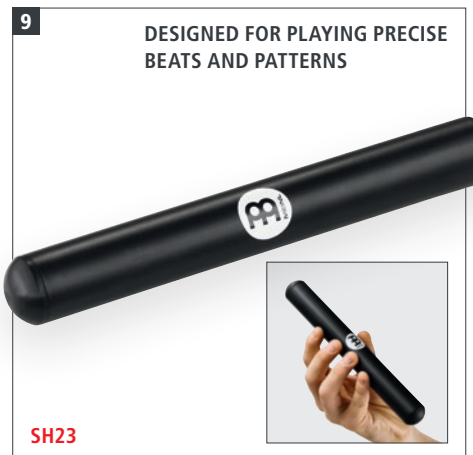
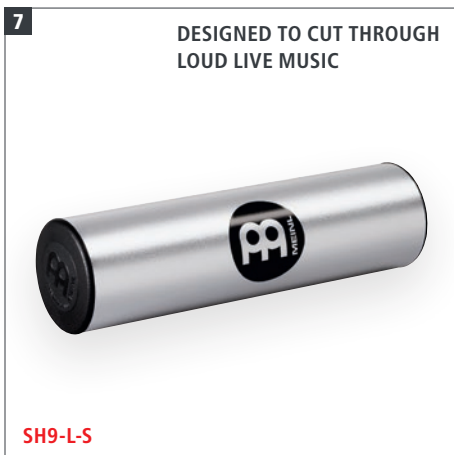
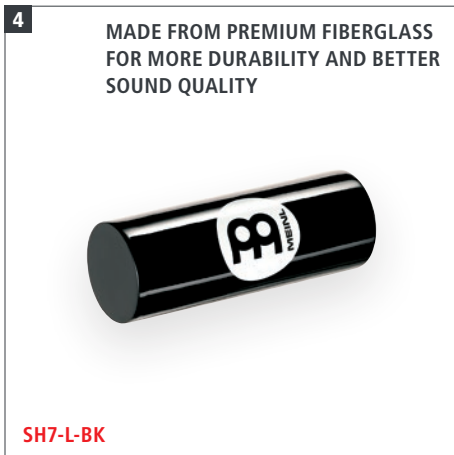

## 1 STUDIO SHAKERS

**SIZES** **SH10-M-BK**: Medium  
**SH10-L-BK**: Large

**MATERIAL** Synthetic

**FEATURE** Deliver a very tasteful and delicate shaker sound with a warm tone and well balanced frequency spectrum

**COLOUR** **BK**: Black

## 2 STUDIOMIX SHAKERS

**SIZES** **SH12-M-BK**: Medium  
**SH12-L-BK**: Large

**MATERIAL** Synthetic

**FEATURE** Textured surface for special sound and positive grip

**COLOUR** **BK**: Black

## 3 CRYSTAL SHAKERS

**SIZE** Large  
**MATERIALS** Synthetic; Acrylic

**FEATURES** Shapes any groove with clarity and feel  
**SH26-L-L**: Perfect for live playing  
**SH26-L-S**: Perfect for studio recordings

## 4 FIBERGLASS SHAKER

**SIZE** Large

**MATERIAL** Premium fiberglass

**FEATURE** Made from premium fiberglass for more durability and better sound quality

**COLOUR** **BK**: Black

## 5 ALUMINUM SHAKERS, OCTAGONAL

**SIZES** **SH8BK**: Small  
**SH88BK**: Medium  
**SH888BK**: Large

**MATERIAL** Aluminum

**FEATURE** Provides a broad dynamic range with lots of volume

**COLOUR** **BK**: Black

## 6 ALUMINUM JINGLE SHAKER

**SIZE** Medium

**MATERIALS** Shaker: Aluminum  
Jingles: Steel

**FEATURE** Two pairs of steel jingles are attached in one row to an octagonal aluminum shaker

**COLOUR** **BK**: Black

## 7 ALUMINUM SHAKER, ROUND

**SIZE** Large

**MATERIAL** Anodized aluminum

**FEATURE** Designed to cut through loud live music

**COLOUR** **S**: Silver

## 8 PROJECTION SHAKER

**SIZE** Large

**MATERIAL** Anodized aluminum

**FEATURES** For comfort and volume; Shimmering, cutting pitch; Exceptional for live playing

**COLOUR** **S**: Silver

**10** CIRCULAR MOTION ENABLES A UNIQUE RATTLING



Spark shaker  
**SH16**

SENSATIONAL EFFECTS ARE PRODUCED WHEN COMBINED WITH ANOTHER SPARK SHAKER



**11** SCREW-MOUNTED DISC ENABLES A TUNABLE PITCH



Spin spark  
**SH17**

**12**



Headed spark  
**SH18**

MOTION SHAKER  
(SEE PAGE 55)



**MS-BK**

**13**



Medium  
**SH20BK**

BY COVERING AND UNCOVERING THE SOUND HOLE, A "WAH-WAH" EFFECT CAN BE ACHIEVED

**14** LOUD AND PENETRATING SOUND DUE TO THE MANY HOLES



**SH3BK**

**15**



Black  
**SH21BK**

**9 PROTON SHAKER**  
**MATERIAL** Aluminum  
**FEATURES** Compact size; Easy to control; Made for precise playing techniques

**10 ORIGINAL SPARK SHAKER**  
**SIZE** Medium  
**MATERIALS** Shaker: Coated steel  
 Pellets: Coated steel  
**FEATURES** Circular motion enables a unique rattling; Spark Shakers may be played in pairs  
**FINISH** Black nickel

**11 SPIN SPARK SHAKER**  
**SIZE** Medium  
**MATERIALS** Shaker: Coated steel  
 Pellets: Coated steel  
**FEATURE** Screw-mounted disc enables a tunable pitch  
**FINISH** Black nickel

**12 HEADED SPARK SHAKER**  
**SIZE** Medium  
**MATERIALS** Shaker: Coated steel  
 Pellets: Coated steel  
 Goatskin head  
**FEATURES** Premium goatskin and a steel shell provide a rattling combination; Swirling effect; Variable pitch  
**FINISH** Black nickel

**13 WAKAH SHAKER**  
**SIZE** Medium  
**MATERIALS** Wooden body and synthetic chamber  
**FEATURE** By covering and uncovering the sound hole, a "wah-wah" effect can be achieved  
**COLOUR** **BK:** Black

**14 LOOP SHAKER**  
**SIZE** Medium  
**MATERIAL** Synthetic  
**FEATURE** Loud and penetrating sound due to the many holes  
**COLOUR** **BK:** Black

**15 U.F.O. SHAKER**  
**SIZE** Medium  
**MATERIAL** Synthetic  
**COLOUR** **BK:** Black

# SHAKERS



## 1 MINI CAJON SHAKERS

**SIZE** 2" W x 2 3/4" H x 2" D  
**MATERIALS** Resonating body: Baltic Birch (*Betula pendula*)  
**SH50**  
 Frontplate: Baltic Birch (*Betula pendula*)  
**SH51**  
 Frontplate: Ovangkol (*Guibourtia ehie*)  
**FEATURES** Compact size; Cutting shaker sound; Miniature size of a Meinl cajon

## 2 MINI CAJON SHAKER SET

**MATERIALS** Resonating body: Baltic Birch (*Betula pendula*)  
 Frontplates: Exotic Zebrano, Burl Wood, Baltic Birch (*Betula pendula*)  
**FEATURES** Three unique timbres for multiple sound options; Various frontplates for easy identification

## 3 WOOD SHAKERS, RECTANGLE

**SIZES** **S:** Small  
**M:** Medium  
**MATERIALS** Baltic Birch (*Betula pendula*)  
 Top and Bottom: Exotic Zebrano  
**FEATURES** Wide sound options; Rectangle shaped

## 4 DUAL CHAMBER SHAKER

**MATERIAL** Baltic Birch Plywood (*Betula pendula*)  
 Top and Bottom: Burl Wood  
**FEATURES** Dual internal chambers for greater shaker control; Easier to play consistent shaker patterns; Ultra-smooth sound

## 5 WOOD SHAKERS, ROUND

**SIZE** 4" length, 1 3/4" diameter  
**MATERIALS** **SH56:** Lime  
**SH58:** Beech  
**SH59:** Oak

**FEATURES** Made from three wood species for different volume; Fits comfortably in your hand  
**SH56:** Soft  
**SH58:** Medium  
**SH59:** Loud

## 6 DOUBLE SHAKER & GANZA

**MATERIALS** Rattan with coconut bottom  
**FEATURES** **D01:** Offers two different sounds in one instrument  
**GA2:** Crystal clear sound, high pitched with a great projection

## 7 CAXIXIS

**SIZES** **CAX1:** Small  
**CAX2:** Medium  
**CAX3:** Large  
**MATERIALS** Rattan with coconut bottom  
**FEATURES** Crystal clear sound, high pitched with a great projection; Woven by hand

# KALIMBAS & CASTANETS



Small  
**KA5-S**

Medium  
**KA9-M**

Medium  
**KA7-M-BK**



WIDE OPENING FOR GREAT WAH-WAH EFFECTS

**KA9WW-BK**



Coral Reef  
**KA17CR**

Lava  
**KA17LV**

Sun  
**KA17SU**



BUILT-IN PICKUP

**PKA17AW**



SEPARATELY ADJUSTABLE

**CM2**

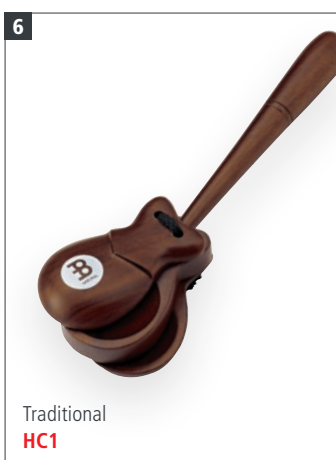

Traditional  
**HC1**



Traditional  
**FC1**

Concert  
**FC2**

## 1 SOLID KALIMBAS

**SIZES** **KA5-S**: Small  
**KA7-M-BK, KA9-M**: Medium  
**MATERIALS** New Zealand Pine (*Pinus radiata*)  
**TUNING** **KA5-S**: g#, c', f', f', c''  
**KA7-M-BK**: e', g, d'', e, c', a, a'  
**KA9-M**: a', c', c', a', A, f', e', e'', b'  
**FEATURES** **KA5-S, KA9-M**: Heat-branded logo  
**KA7-M-BK**: Extra wide tongues

## 2 WAH-WAH KALIMBA

**MATERIALS** New Zealand Pine (*Pinus radiata*)  
**TUNING** a', c', c', a', A, f', e', e'', b'  
**COLOUR** **BK**: Black

## 3 SOUND HOLE DESIGNER KALIMBAS

**MATERIALS** **KA17CR, KA17LV**: Acacia  
**KA17SU**: Sapele  
**TUNING** C Major: d'', b', g', e', c', a, f, d, c, e, g, b, d', f', a', c'', e'' (17 notes)  
**FEATURES** Easy for all skill levels  
**INCLUDES** Travel case; Microfiber cleaning cloth; Tuning hammer  
**DESIGNS** **CR**: Coral Reef; **LV**: Lava; **SU**: Sun

## 4 SOLID PICKUP KALIMBA

**MATERIALS** American Walnut  
**TUNING** C Major: d'', b', g', e', c', a, f, d, c, e, g, b, d', f', a', c'', e'' (17 notes)  
**FEATURES** Easy for all skill levels; Built-in pickup  
**INCLUDES** Travel case; Microfiber cleaning cloth; Tuning hammer

## 5 CASTANET MACHINE

**SIZE** 7 1/2" x 5"  
**MATERIAL** Indian Rosewood  
**FEATURES** Separately adjustable; Full and cutting resonance

## 6 TRADITIONAL HAND CASTANET

**SIZE** Traditional  
**MATERIAL** Indian Rosewood

## 7 FINGER CASTANETS

**SIZES** **FC1**: Traditional  
**FC2**: Concert  
**MATERIAL** Indian Rosewood

# SOUND EFFECTS

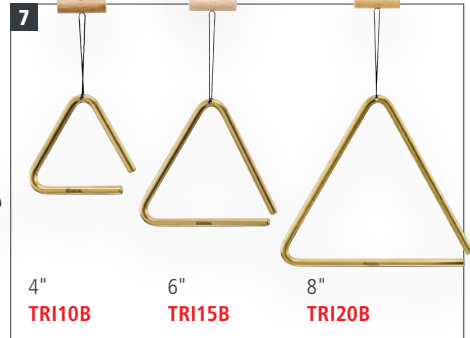

## 1 BIRDS & WATERFALLS

**MATERIALS** **B17RY, WA7BK:** Premium fiberglass  
**B11NT, WA1NT, B12NT, WA2NT:** Siam Oak (*Hevea brasiliensis* Muell.-Arg.)

**FEATURES** Durable cord  
**BI:** Realistically imitate the sound of a flock of birds; Bright sound with big dynamic range  
**WA:** Realistically imitate the sound of a rippling waterfall

**COLOURS** **BK:** Black  
**NT:** Natural  
**RY:** Red/Yellow

## 2 AJUCH BELLS

**SIZES** 30" long  
**MABS:** Small bells  
**MABM:** Medium bells  
**MABL:** Large bells

**MATERIAL** Brass and synthetic wax

**FEATURES** Cast bells; Solid hook for easy attachment; Synthetic wax rope

**INCLUDES** Canvas pouch for safe and simple storage

**COLOURS** **MABS:** Brown and Turquoise  
**MABM:** Black  
**MABL:** Dark Red and Gold

## 3 SLEIGHT BELLS

**SIZES** **SLB7:** 7 bells; **SLB12:** 12 bells; **SLB25:** 25 bells

**MATERIALS** Steel bells; Wooden handle

**FEATURES** Ergonomic grip; True sleigh bell sound

## 4 KOKIRIKO

**MATERIAL** Wood

**FEATURES** Ergonomically shaped handle; Durable cord

**COLOUR** **AM:** Amber

## 5 ORCHESTRA RATCHET

**MATERIALS** Chrome plated steel  
Hood Pine Tines

**FEATURES** Produce quick notes like a cabasa or long-sustaining rattle effects; Wooden internal paddles project clearly; Easy to grip metal hand crank; Mountable on a stand

## 6 WOODEN FROGS

**SIZES** **M:** Medium; **L:** Large

**FEATURE** Authentic "ribbit" sound

## 7 TRIANGLES

**SIZES** **TRI10B:** 4"  
**TRI15B:** 6"  
**TRI20B:** 8"

**MATERIAL** Solid brass

**INCLUDES** Wooden holder with braided nylon cord  
Metal beater



27 bells  
**BT27**



14 bells  
**BT14**



SPECIAL BRONZE ALLOY

**FICY-14**



**PFICY-2**



**FICY-2**

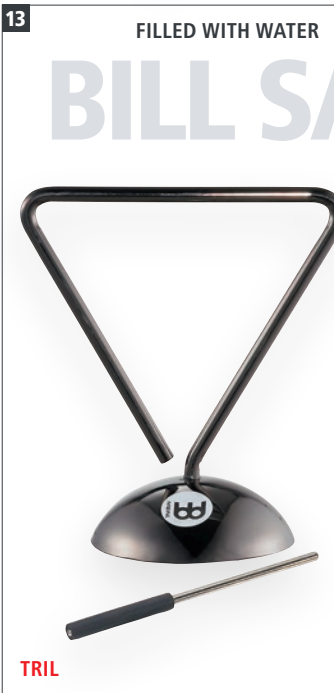

FILLED WITH WATER

**TRIL**

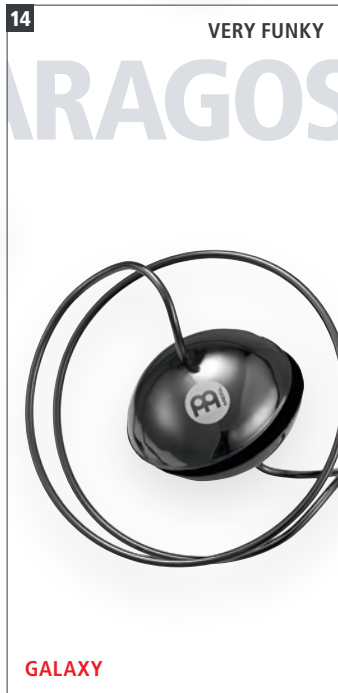

VERY FUNKY

**GALAXY**



**BOWL**



**WW2BK**



**N11AM**

**8 STAND ALONE BELL TREE**

**MATERIAL** Solid brass bells  
**FEATURE** Adjustable metal stand  
**INCLUDES** Striker

**9 HAND HELD BELL TREE**

**MATERIAL** Solid brass bells  
**INCLUDES** Striker

**10 HANGING FINGER CYMBALS**

**SIZES** 2 3/8" diameter  
**MATERIAL** Special bronze alloy  
**FEATURES** Shimmering sound; Durable cord

**11 PROFESSIONAL FINGER CYMBALS**

**SIZE** 2 5/8" diameter  
**MATERIAL** Special bronze alloy  
**FEATURES** Identical, high pitched sound; Durable cord

**12 ORIENTAL FINGER CYMBALS**

**SIZE** 2 3/8" diameter  
**MATERIAL** Special bronze alloy

**BILL SARAGOSA LINE 13 14 15**

**MATERIAL** Special steel alloy  
**FEATURE** Wide sound spectrum  
**FINISH** Black nickel

**13 LIQUID TRIANGLE**

**FEATURES** Special steel alloy, filled with water  
**INCLUDES** Metal beater

**14 GALAXY**

**FEATURES** Two resonant liquid chambers are connected by a long steel spiral liquid; Inside the two chambers exerts variable dampening on the steel resonator plates  
**INCLUDES** Metal beater

**15 HELIX BOWL**

**FEATURES** Wonderful instrument consisting of a steel helix welded to a resonating chamber; Deep resonating wah-wah effect  
**INCLUDES** Metal beater

**16 WAH-WAH TUBE**

**SIZE** Large (low pitch)  
**MATERIAL** Aluminum  
**INCLUDES** Rubber mallet  
**COLOUR** **BK:** Black

**17 THE NIGHT**

**MATERIALS** Solid steel balls and cylinder  
Wooden body  
**COLOUR** **AM:** Amber

# CHIMES

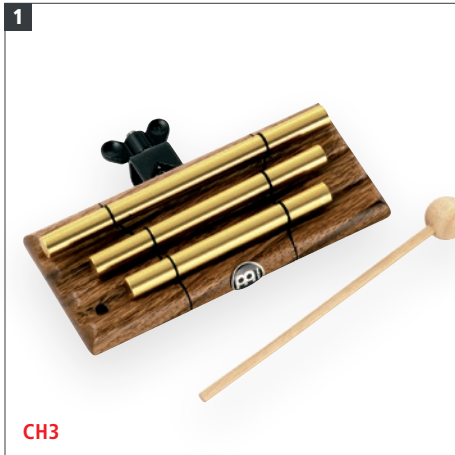

**CH3**



12 bars  
**CH-H12**

18 bars  
**CH-H18**

24 bars  
**CH-H24**



12 pegs  
**CH-HPEG**

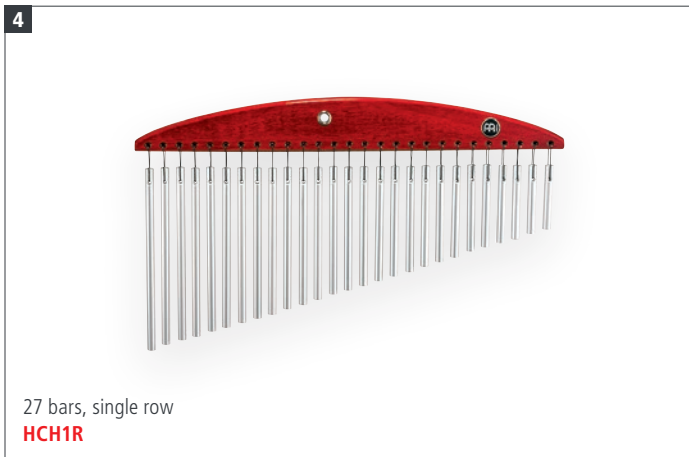

27 bars, single row  
**HCH1R**



33 bars, single row  
**HCH2BK**



27 bars, single row  
**CH27VWB**

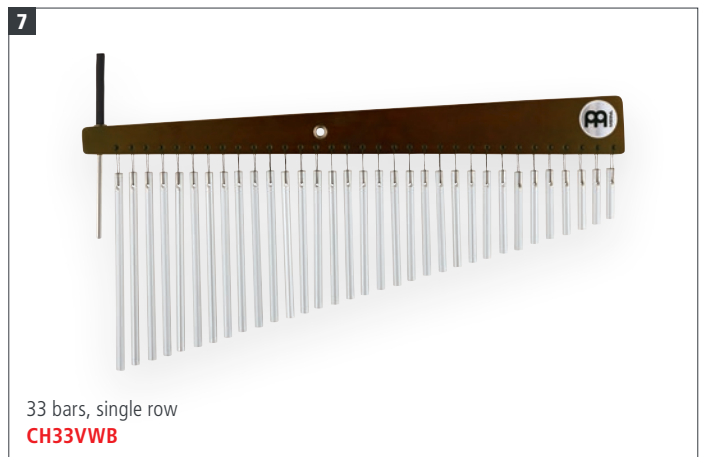

33 bars, single row  
**CH33VWB**

## 1 TRI TONE CHIMES

**MATERIAL** Gold anodized aluminum alloy  
**FEATURES** Three free-floating bars create a very long sustain  
Tonally matched bars  
Mountable on all common L-rods  
**INCLUDES** Wooden beater and holder

## 2 HAND CHIMES

**SIZES** **CH-H12:** 12 bars  
**CH-H18:** 18 bars  
**CH-H24:** 24 bars  
**MATERIAL** Gold anodized aluminum alloy  
**FEATURES** Can easily be played by hand  
Produce a full and rich sound

## 3 PEG CHIMES

**SIZE** 12 pegs  
**MATERIAL** Gold plated steel  
**FEATURE** Perfect for special accents

## 4 HEADLINER® SERIES CHIMES, 27 BARS

**SIZE** 27 bars, single row  
**MATERIAL** Silver anodized aluminum alloy  
**FEATURES** Great and affordable addition to any percussion set-up  
Produce a full and warm chime sound  
**COLOUR** **R:** Red

## 5 HEADLINER® SERIES CHIMES, 33 BARS

**SIZE** 33 bars, single row  
**MATERIAL** Silver anodized aluminum alloy  
**FEATURE** Generate a full sound spectrum  
**COLOUR** **BK:** Black

## 6 VINTAGE CHIMES, 27 BARS

**SIZE** 27 bars, single row  
**MATERIAL** Silver anodized aluminum alloy  
**FEATURE** Excellent addition to any drum or percussion arrangement  
**COLOUR** **VWB:** Vintage Wine Barrel

## 7 VINTAGE CHIMES, 33 BARS

**SIZE** 33 bars, single row  
**MATERIAL** Silver anodized aluminum alloy  
**FEATURES** Can be used in a wide range of musical styles  
Producing a sweet sparkling sound  
**INCLUDES** Holder; Striker  
**COLOUR** **VWB:** Vintage Wine Barrel





12 bars, single row  
**CH12**

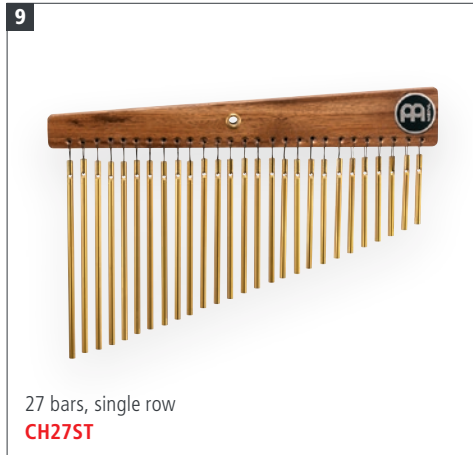

27 bars, single row  
**CH27ST**



27 bars, single row  
**CH27**

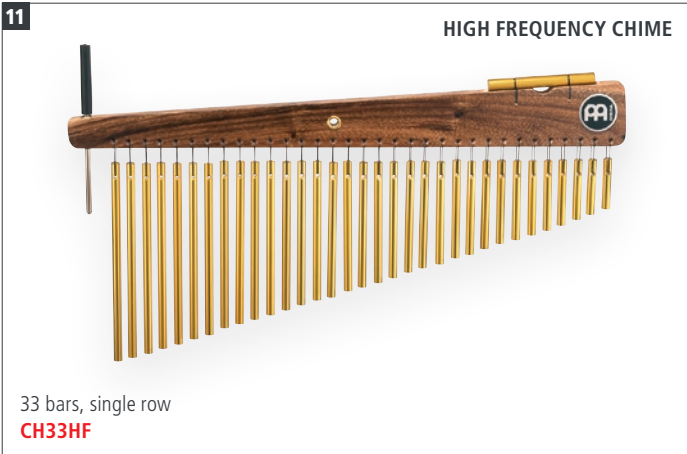

33 bars, single row  
**CH33HF**



66 bars, double row  
**CH66HF**

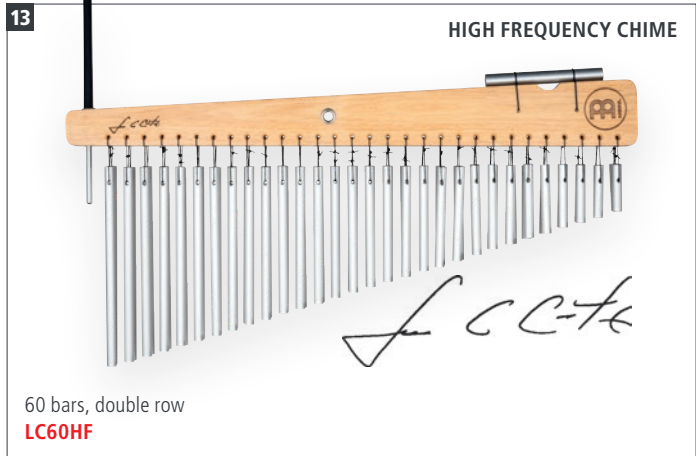

60 bars, double row  
**LC60HF**



LUIS CONTE

**8 CHIMES, 12 BARS**  
**SIZE** 12 bars, single row  
**MATERIAL** Gold anodized aluminum alloy  
**FEATURES** Produce a beautiful, high pitched sound  
 Ideal for tasteful chime accents

**9 STUDIO CHIMES, 27 BARS**  
**SIZE** 27 bars, single row  
**MATERIAL** Gold anodized aluminum alloy  
**FEATURE** Slightly thinner bars for a full, rich and delicate sound

**10 CHIMES, 27 BARS**  
**SIZE** 27 bars, single row  
**MATERIAL** Gold anodized aluminum alloy  
**FEATURES** Produce a full sound with a wide tonal spectrum  
 Ideal for smaller stages and club scenes

**11 CHIMES, 33 BARS**  
**SIZE** 33 bars, single row  
**MATERIAL** Gold anodized aluminum alloy  
**FEATURES** Produce a very bright sound with a pronounced upper overtone spectrum  
 Perfect for all live situations  
**INCLUDES** Holder; Striker

**12 CHIMES, 66 BARS**  
**SIZE** 66 bars, double row  
**MATERIAL** Gold anodized aluminum alloy  
**FEATURES** Produces a rich and full sound  
 Cut through any band setting  
 High frequency chime  
**INCLUDES** Holder; Striker

**13 ARTIST SERIES CHIMES LUIS CONTE**  
**SIZE** 60 bars, double row  
**MATERIAL** Silver anodized aluminum alloy  
**FEATURES** Produces a bright sound from the medium and low pitched bars  
 Perfect for all studio situations  
 High frequency chime  
**INCLUDES** Holder; Striker

# DIDGERIDOOS

**1** COLOURFUL HAND-PAINTED ACCENTS HARKEN TO TRADITIONAL NATIVE AUSTRALIAN DESIGNS

47" **DDG1-BK**      47" **DDG1-BR**      47" **DDG1-R**

**2**

51" **SDDG1-BK**      S-Shape, 51" **SDDG2-BK**

**3** TWO TELESCOPING SECTIONS

36"-62" **TSDDG1-BK**

## 1 WOOD DIDGERIDOOS

SIZE 47"  
 MATERIAL Bamboo  
 TUNING **DDG1-BK**: E  
**DDG1-BR**: D#  
**DDG1-R**: E  
 COLOURS **BK**: Black  
**BR**: Brown  
**R**: Red

## 2 SYNTHETIC DIDGERIDOOS

SIZE 51"  
 MATERIAL Lightweight synthetic  
 TUNING **SDDG1-BK**: D  
**SDDG2-BK**: C#  
 FEATURES **SDDG2-BK**  
 "S" shaped body for bigger sounds  
 Distinctive, full drone and harmonic overtones  
 COLOUR **BK**: Black

## 3 TROMBONE DIDGERIDOO

SIZE 36"-62"  
 MATERIAL Premium fiberglass  
 TUNING from: G#, G, F#, F, E, D#, D, C#, C  
 FEATURE Two telescoping sections for variable pitch  
 COLOUR **BK**: Black



60"  
**TSDDG2-BK**



57"  
**PROFDDG1-BK**



57"  
**PROSDDG1-BK**



61"  
**SDDG1-SI**



8 1/2" x 5"  
**DDG-BOX**



9  
**100% PURE BEESWAX**

**DDG-MP**

SMALL IN SIZE BUT BIG IN SOUND

DIDGERIDOOS

#### 4 SYNTHETIC SLIDE TRAVEL DIDGERIDOO

**SIZE** Portable: 24"; Playable: 60"  
**MATERIAL** Lightweight synthetic  
**TUNING** D  
**FEATURES** Contractible body for easy travel  
Distinctive, full drone and harmonic overtones  
**INCLUDES** Bag  
**COLOUR** **BK:** Black

#### 5 PRO FIBERGLASS DIDGERIDOO

**SIZE** 57"  
**MATERIAL** Premium fiberglass  
**TUNING** D  
**COLOUR** **BK:** Black

#### 6 PRO SYNTHETIC DIDGERIDOO

**SIZE** 57"  
**MATERIAL** Lightweight synthetic  
**TUNING** D  
**COLOUR** **BK:** Black

#### 7 ARTIST SERIES DIDGERIDOO SIMON "SI" MULLUMBY

**SIZE** 61"  
**MATERIAL** Premium fiberglass  
**TUNING** F  
**COLOUR** Grey

#### 8 TRAVEL DIDGERIDOO (US PATENT)

**SIZE** 8 1/2" x 5"  
**MATERIAL** Mahogany Wood (*Swietenia macrophylla*)  
**TUNING** C  
**FEATURES** Heat-branded logo  
Compact size

#### 9 DIDGERIDOO MOUTHPIECE

**SIZE** Inner diameter: 30 mm  
Outer diameter: 60 mm  
**MATERIAL** Antiseptic beeswax  
**FEATURES** Easy mountable  
100% pure beeswax  
Fits perfect on our didgeridoos

# RAINSTICKS & RAINMAKER

1



16"  
RS1BK-S

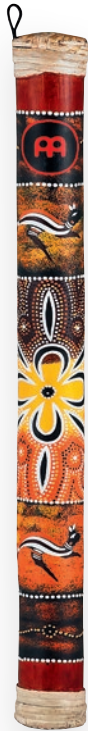

24"  
RS1R-M



31 1/2"  
RS1BK-M/L

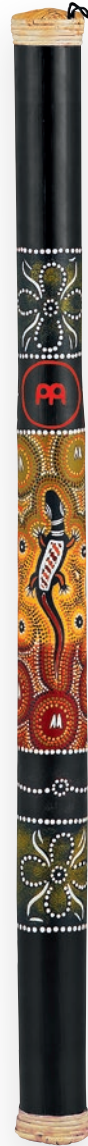

39"  
RS1BK-L



47"  
RS1BK-XL



60"  
RS1BK-XXL



## 1 WOOD RAINSTICKS

**SIZES**  
**S:** 16"  
**M:** 24"  
**M/L:** 31 1/2"  
**L:** 39"  
**XL:** 47"  
**XXL:** 60"  
**MATERIAL** Bamboo  
**COLOURS** **BK:** Black  
**R:** Red

## 2 SYNTHETIC RAINSTICK

**SIZE** **L:** 39"  
**MATERIAL** Lightweight synthetic  
**COLOUR** **R:** Red

## 3 PRO RAINSTICK

**SIZE** **XL:** 47"  
**MATERIAL** Rattan wrapped Bamboo  
**FEATURES** Long susurration  
 Authentic rain sounds

## 4 PRO RAINMAKER

**SIZE** 3 3/4" W x 25 1/4" H x 3 3/4" D  
**MATERIAL** Baltic Birch (*Betula pendula*)  
**FEATURES** Ultra long sustain  
 Authentic rain sound  
 Natural birch wood construction  
**COLOUR** **NT:** Natural



# SAMBA

A close-up, artistic photograph of a Samba tamborim drum. The drum's metal rim and central spike are in sharp focus, while the background is a dark, bokeh-filled space with warm, glowing light spots. The word 'SAMBA' is written in large, red-outlined, sans-serif capital letters at the top of the image.

Samba percussion instruments are the heartbeat of Brazil's vibrant Samba music, driving the lively rhythms that define this iconic genre. Instruments like the surdo, tamborim, and pandeiro create the powerful, syncopated beats that bring energy to Samba performances, from street parades to stage shows. Each instrument plays a unique role, blending deep, resonant bass with sharp, bright tones to form the intricate layers of Samba's rhythmic pulse. Whether you're playing in a Samba band or exploring its infectious rhythms on your own, these instruments offer an exciting, dynamic way to experience the spirit of Brazil.

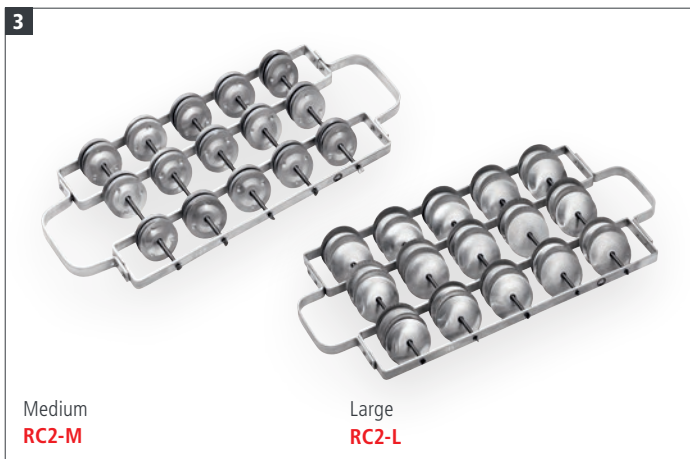
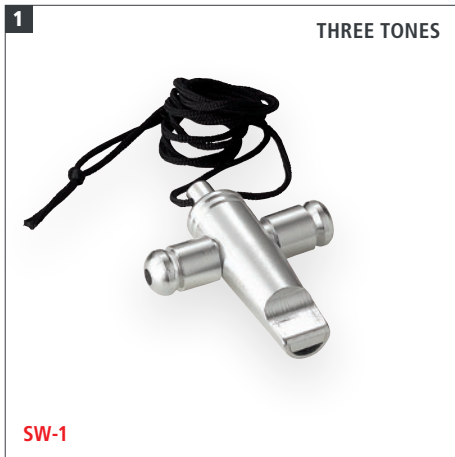

**1 SAMBA WHISTLE**

**MATERIAL** Aluminum  
**INCLUDES** Neck lanyard

**2 ALUMINUM SAMBA SHAKERS**

**SIZES** **S**: Small; **M**: Medium; **L**: Large  
**MATERIAL** Aluminum  
**FEATURE** Produces warm and cutting shaker sound

**3 ALUMINUM ROCARS**

**SIZES** **RC2-M**: Medium; **RC2-L**: Large  
**MATERIAL** Aluminum frame and jingles  
**FEATURES** Light weight frame; Loud projection

**4 MODERN STYLE A-GO-GO STEEL FINISH MODELS**

**SIZES** **STBAG1, STBAG5**: Small  
**STBAG2**: Large  
**MATERIAL** Special steel alloy  
**FEATURE** Tonally matched  
**FINISHES** **STBAG1, STBAG2**: Hand brushed steel  
**STBAG5**: Black powder coating

**5 MODERN STYLE A-GO-GO CHROME FINISH MODELS**

**SIZES** **STBAG4**: Small; **STBAG2**: Large  
**MATERIAL** Special steel alloy  
**FEATURES** Flexible connection; Bright sound  
**FINISH** High polished chrome

**6 TRADITIONAL STYLE A-GO-GO BELL**

**SIZE** Medium  
**MATERIAL** Special steel alloy  
**FEATURES** Traditional shape; Flexible connection  
**FINISH** High polished chrome

**7 TRIPLE A-GO-GO BELL**

**SIZE** Medium  
**MATERIAL** Chrome plated steel  
**FEATURES** Traditional Shape; Three tonally matched bells in equal intervals; Spring handle enables counterpoint rhythms

# ALUMINUM SURDOS

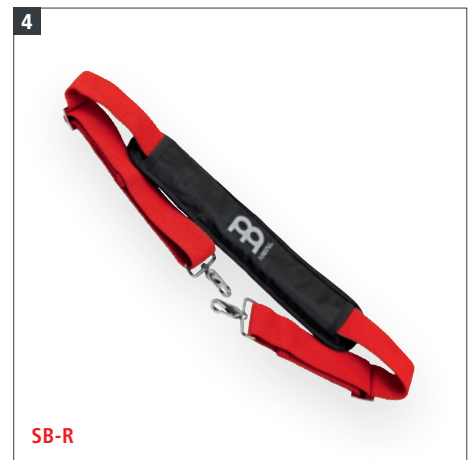
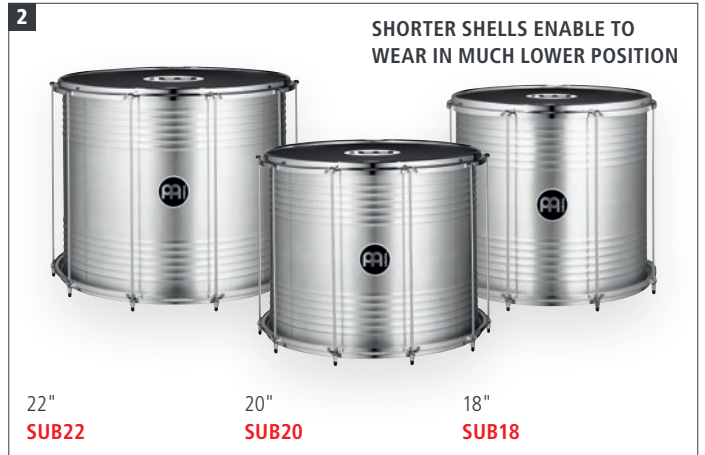

## 1 CLASSIC SERIES SURDOS (PATENTED)

**SIZES** **SUC16:** 16" diameter, 20" tall  
**SUC18:** 18" diameter, 22" tall  
**SUC20:** 20" diameter, 24" tall

**MATERIAL** Aluminum

**FEATURES** Countersunk bolt heads  
Traditional rim  
Chrome plated hardware  
Traditional plain shell  
8 tuning lugs (16" & 18" models)  
10 tuning lugs (20" model)  
Logo applied from underneath the head  
(CN, TH, US patent)

**INCLUDES** Tuning key

## 2 BAHIA ALUMINUM SURDOS (PATENTED)

**SIZES** **SUB18:** 18" diameter, 16" tall  
**SUB20:** 20" diameter, 16" tall  
**SUB22:** 22" diameter, 18" tall

**MATERIAL** Aluminum

**FEATURES** Countersunk bolt heads  
Chrome plated hardware  
Two head options  
8 tuning lugs (18" model)  
10 tuning lugs (20" & 22" models)  
Logo applied from underneath the head  
(CN, TH, US patent)

**INCLUDES** Tuning key

## 3 TRADITIONAL ALUMINUM SURDOS (PATENTED)

**SIZES** **SU16:** 16" diameter, 20" tall  
**SU18:** 18" diameter, 22" tall  
**SU20:** 20" diameter, 24" tall  
**SU22:** 22" diameter, 24" tall

**MATERIAL** Aluminum

**FEATURES** Countersunk bolt heads  
Chrome plated hardware  
Two head options  
8 tuning lugs (16" & 18" models)  
10 tuning lugs (20" & 22" models)  
Logo applied from underneath the head  
(CN, TH, US patent)  
**SU22-L, SU20-L, SU18-L, SU16-L:**  
Height adjustable legs

**INCLUDES** Tuning key





22" **HEAD-69**      20" **HEAD-68**      18" **HEAD-67**      16" **HEAD-66**



SHORTER SHELLS ENABLE TO WEAR IN MUCH LOWER POSITION

22" **SUB22AB-M**      20" **SUB20AB-M**      18" **SUB18AB-M**



22" **SU22AB-M**      20" **SU20AB-M**      18" **SU18AB-M**      16" **SU16AB-M**

SIX-PLY HARDWOOD SHELLS FOR A FULL AND WARM SOUND

SAMBA BEATERS (SEE PAGE 125)



**SB1**      **SB4**      **SB5**

SURDO BEATER HOLDER (SEE PAGE 125)



**SBH**



22" **SU22-L-AB-M**      20" **SU20-L-AB-M**      18" **SU18-L-AB-M**      16" **SU16-L-AB-M**

HEIGHT ADJUSTABLE LEGS

#### 4 SAMBA BELT

**MATERIAL** Cotton  
**FEATURES** Length adjustable  
 Adjustable shoulder padding  
 Strong attachment hooks  
**COLOUR** **R:** Red

#### 5 SURDO NAPA HEADS

**SIZES** **HEAD-66:** 16"  
**HEAD-67:** 18"  
**HEAD-68:** 20"  
**HEAD-69:** 22"  
**MATERIALS** Nylon and leather cloth  
**FEATURE** Bonded in a hoop  
**COLOUR** Black

#### 6 BAHIA WOOD SURDOS (PATENTED)

**SIZES** **SUB18:** 18" diameter, 16" tall  
**SUB20:** 20" diameter, 16" tall  
**SUB22:** 22" diameter, 18" tall  
**MATERIAL** Six-ply hardwood shells  
**FEATURES** Countersunk bolt heads  
 Chrome plated hardware  
 Two head options  
 8 tuning lugs (18" model)  
 10 tuning lugs (20" & 22" models)  
 Logo applied from underneath the head (CN, TH, US patent)  
**INCLUDES** Tuning key  
**COLOUR** **AB:** Antique Brown  
**FINISH** Matte

#### 7 TRADITIONAL WOOD SURDOS (PATENTED)

**SIZES** **SU16:** 16" diameter, 20" tall  
**SU18:** 18" diameter, 22" tall  
**SU20:** 20" diameter, 24" tall  
**SU22:** 22" diameter, 24" tall  
**MATERIAL** Six-ply hardwood shells  
**FEATURES** Countersunk bolt heads  
 Chrome plated hardware  
 Two head options  
 8 tuning lugs (16" & 18" models)  
 10 tuning lugs (20" & 22" models)  
 Logo applied from underneath the head (CN, TH, US patent)  
**SU22-L, SU20-L, SU18-L, SU16-L:** Height adjustable legs  
**INCLUDES** Tuning key  
**COLOUR** **AB:** Antique Brown  
**FINISH** Matte

# TIMBAS, TANTAM, REBOLO, REPINIQUES & CUICAS



## 1 TIMBAS (PATENTED)

**SIZES** **TIM1428:** 14" diameter, 28" tall  
**TIM1435:** 14" diameter, 35" tall

**MATERIALS** Poplar Wood (*Populus*)  
Replaceable synthetic head

**FEATURES** Lightweight shell; Chrome plated hardware; Comfortable rounded rim; Strong hook to carry it on a belt; Logo applied from underneath the head (CN, TH, US patent)

**INCLUDES** Tuning key

**COLOUR** **AB-M:** Antique Brown, matte

## 2 TANTAM

**SIZE** 14" diameter, 28" tall

**MATERIALS** Poplar Wood (*Populus*)  
Replaceable synthetic Napa head

**FEATURES** Lightweight shell; Chrome plated hardware; Strong hooks to carry it on a belt

**INCLUDES** Tuning key

**COLOUR** **AB-M:** Antique Brown, matte

## 3 REBOLO

**SIZE** 12" diameter, 18" tall

**MATERIALS** Poplar Wood (*Populus*)  
Replaceable synthetic Napa head

**FEATURES** Lightweight shell; Chrome plated hardware; Mechanical lug tuning; Strong hooks to carry it on a belt

**INCLUDES** Tuning key

**COLOUR** **AB-M:** Antique Brown, matte

## 4 ALUMINUM REPINIQUES (PATENTED)

**SIZES** **RE10:** 10" diameter, 10" tall  
**RE12:** 12" diameter, 12" tall

**MATERIALS** Aluminum  
Replaceable synthetic heads

**FEATURES** Countersunk bolt heads; Chrome plated hardware; 6 tuning lugs (10" model); 8 tuning lugs (12" model); Logo applied from underneath the head (CN, TH, US patent)

**INCLUDES** Tuning key

## 5 ALUMINUM CUICAS

**SIZES** **QW6:** 6" diameter  
**QW10:** 10" diameter

**MATERIALS** Aluminum  
Hand selected goatskin heads

**FEATURE** **QW10:** Countersunk bolt heads

**INCLUDES** Tuning key

**6**



**PROFESSIONAL SNARE THROW-OFF MECHANISM**



14" x 4"  
**CA14**

12" x 4 1/2"  
**CA12**

**7**

**TRADITIONAL STYLE WITH GUITAR STRINGS**



12" x 6"  
**CA12T**

**IMPROVED**

**8**

**MESH HEAD FOR SUPER LOW VOLUME PRACTICE**



ABS, Black  
**STBR06ABS-BK**

**9**



ABS, Black  
**TBR06ABS-BK**



ABS, Green  
**TBR06ABS-GR**

**TAMBORIM STICKS (SEE PAGE 124)**



**TBR5-BK**      **TBR5-R**



ABS, Red  
**TBR06ABS-R**



ABS, Yellow  
**TBR06ABS-Y**

**PROFESSIONAL TAMBORIM BAG (SEE PAGE 129)**



**MTAB-06**



Aluminum  
**TBR06ALU**



**6 ALUMINUM CAIXAS (PATENTED)**

**SIZES** **CA12:** 12" diameter, 4 1/2" tall  
**CA14:** 14" diameter, 4" tall

**MATERIALS** Aluminum; Replaceable synthetic heads

**FEATURES** Countersunk bolt heads; Steel snare wires; Professional snare throw-off mechanism; Logo applied from underneath the head (CN, TH, US patent)

**INCLUDES** Tuning key

**7 TRADITIONAL ALUMINUM CAIXA (PATENTED)**

**SIZE** 12" diameter, 6" tall

**MATERIALS** Aluminum; Replaceable synthetic heads

**FEATURES** Traditional style snares made from guitar strings; Extra deep body; Countersunk bolt heads; Logo applied from underneath the head (CN, TH, US patent)

**INCLUDES** Tuning key

**8 SILENT TAMBORIM**

**SIZE** 6" diameter

**MATERIALS** Molded ABS

**FEATURE** Replaceable mesh head; Floatune Tuning System; Countersunk bolt lugs; Mesh head for super low volume practice

**INCLUDES** Washer as tuning key

**COLOUR** **BK:** Black

**9 FLOATUNE TAMBORIMS (PATENTED)**

**SIZE** 6" diameter

**MATERIALS** Replaceable synthetic heads

**ABS:** ABS  
**ALU:** Aluminum

**FEATURES** Floatune Tuning System; Countersunk bolt lugs; Logo applied from underneath the head (CN, TH, US patent)

**INCLUDES** Washer as tuning key

**COLOURS** **BK:** Black  
**GR:** Green  
**R:** Red  
**Y:** Yellow

# POP OFF CONGAS

**1**



11 1/2"  
**VR-POH115-SH**

9 1/2"  
**VR-POH95-SH**

8"  
**VR-POH8-SH**



11 1/2"  
**VR-POH115-NH**

9 1/2"  
**VR-POH95-NH**

8"  
**VR-POH8-NH**

**MAY BE PLAYED BY THEMSELVES AS A SMALL HAND DRUM**

**2**

**CAN BE TAKEN OFF THE DRUM INSTANTLY WITHOUT ANY TUNING**



**BOOM SERIES**



11 1/2" x 24 1/2"  
**VR-CPO115-SH**

9 1/2" x 23"  
**VR-CPO95-SH**

8" x 21"  
**VR-CPO8-SH**

Set, 3 pcs.  
**VR-CPOSET-SH**

**STACKABLE FOR EASY STORAGE AND TRANSPORTATION**



**SOFT SOUND SERIES**



11 1/2" x 24 1/2"  
**VR-CPO115-NH**

9 1/2" x 23"  
**VR-CPO95-NH**

8" x 21"  
**VR-CPO8-NH**

Set, 3 pcs.  
**VR-CPOSET-NH**

## 1 POP OFF HEADS

**SIZES** **VR-POH8:** 8" head diameter  
**VR-POH95:** 9 1/2" head diameter  
**VR-POH115:** 11 1/2" head diameter

**MATERIALS** **SH:** Synthetic head  
**NH:** Napa head

**FEATURES** Available as Napa style (soft sound) or standard synthetic (sharp sounds)  
Instantly take on or off your Meinl Pop Off Conga  
May be played by themselves as a small hand drum  
Nylon-loop for easy removal  
Pre-tuned

## 2 POP OFF CONGAS

**SIZES** **VR-CPO8**  
8" head diameter, 21" height  
**VR-CPO95**  
9 1/2" head diameter, 23" height  
**VR-CPO115**  
11 1/2" head diameter, 24 1/2" height  
**VR-CPOSET**  
8" x 21"; 9 1/2" x 23"; 11 1/2" x 24 1/2"

**MATERIALS** Synthetic shell  
**SH:** Synthetic head  
**NH:** Napa head

**FEATURES** Synthetic shell is perfect for outdoor playing  
Non-slip rubber bottom  
Great for any skill level or style  
Stackable for easy storage and transportation  
**SH:** Removable, pre-tuned synthetic head for cutting sounds with sharp attack  
**NH:** Removable, pre-tuned Napa head creates softer, warmer sound

**INCLUDES** **VR-CPOSET:** Three wooden beaters

# POP OFF BASS DRUMS



POP OFF CONGAS & BASS DRUMS

## 1 POP OFF BASS DRUM HEADS

**SIZES** **VR-POHBD10:** 10" head diameter  
**VR-POHBD12:** 12" head diameter  
**VR-POHBD14:** 14" head diameter

**MATERIALS** **SH:** Synthetic head  
**NH:** Napa head

**FEATURES** Available as Napa style (soft sound) or standard synthetic (sharp sounds)  
 Instantly take on or off your Meinl Pop Off Bass Drum  
 Reverse Dot below the head for deeper sounds  
 May be played by themselves as a small hand drum  
 Nylon-loop for easy removal  
 Pre-tuned

## 2 POP OFF BASS DRUMS

**SIZES** **VR-BDPO10**  
 10" head diameter, 18" height  
**VR-BDPO12**  
 12" head diameter, 19 1/2" height  
**VR-BDPO14**  
 14" head diameter, 23 1/2" height  
**VR-BDPOSET**  
 10" x 18"; 12" x 19 1/2"; 14" x 23 1/2"

**MATERIALS** Synthetic shell  
**SH:** Synthetic head  
**NH:** Napa head

**FEATURES** Synthetic shell is perfect for outdoor playing  
 Non-slip rubber bottom  
 Great for any skill level or style  
 Lower tones with great resonance  
 Reverse Dot below the head for deeper sounds  
 Stackable for easy storage and transportation  
**SH:** Removable, pre-tuned synthetic head for cutting sounds with sharp attack  
**NH:** Removable, pre-tuned Napa head creates softer, warmer sound

**INCLUDES** **VR-BDPOSET:** Three wooden beaters

# CULTURE INSTRUMENTS



Cultural percussion instruments like doumbeks, darbukas, ibo drums, and talking drums carry rich musical traditions from around the globe. The doumbek and darbuka, with their roots in Middle Eastern music, offer sharp, staccato rhythms and deep, resonant tones, perfect for intricate hand drumming patterns. Ibo drums, often used in African and Latin music, bring a unique ceramic timbre, while talking drums, known for their pitch-changing capabilities, are an integral part of West African communication and storytelling traditions. These instruments not only offer diverse sounds but also connect musicians to deep cultural histories, making them a powerful addition to any percussive setup.



**BE1R**



8 1/2" Bayan & 5 1/2" Dayan  
**TABLA**



MADE BY MASTER CRAFTSMEN IN INDIA

9" Bayan & 5 1/2" Dayan  
**PRO-TABLA**



TRADITIONAL TTR-RIMS

6 3/4" & 12" Iya  
**BA3BK**

5 3/4" & 8 3/4" Itotele  
**BA2BK**

5 1/4" & 8" Okonkolo  
**BA1BK**

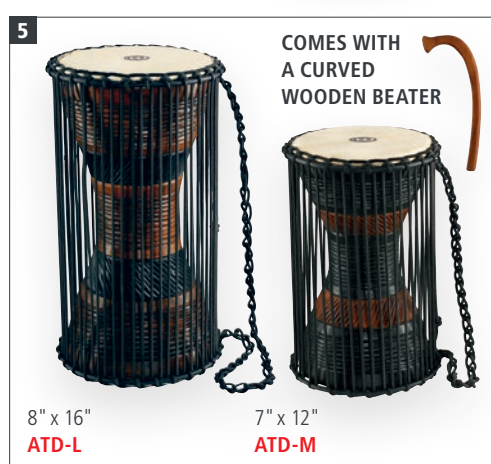

COMES WITH A CURVED WOODEN BEATER

8" x 16"  
**ATD-L**

7" x 12"  
**ATD-M**

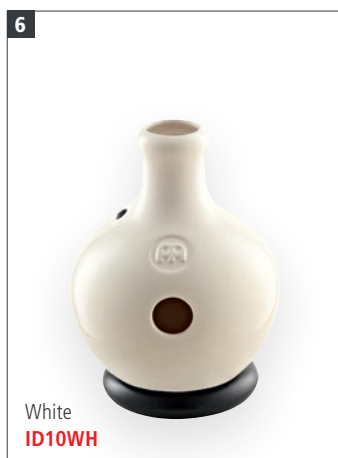

White  
**ID10WH**



RAWHIDE PLAYING SURFACE

**ID3GO**

**ID4BKO**

EXTRA FIBERGLASS PLAYING SURFACE



THE FIBERGLASS LIQUID IBO DRUM IS FILLED WITH WATER

**ID9BK/WH**

## 1 BERIMBAU

**MATERIAL** Premium fiberglass  
**INCLUDES** Small Caxixi; Metal plate; Wooden stick; Carrying bag  
**COLOUR** **R:** Red

## 2 TABLA SET

**SIZES** 5 1/2" Dayan & 8 1/2" Bayan  
**MATERIALS** Chrome plated copper with goatskin head  
Mahogany with goatskin head  
**FEATURE** Nylon straps for longer durability  
**INCLUDES** Padded support rings; Tuning hammer

## 3 ARTISAN EDITION TABLA SET

**SIZES** 5 1/2" Dayan & 9" Bayan  
**MATERIALS** Copper with goatskin head  
Mahogany with goatskin head  
**FEATURES** Traditional tuning system; Rawhide thongs  
**INCLUDES** Tuning hammer and wooden tuning dowel; Ring pads; Protective head covers

## 4 BATAS

**SIZES** **BA1:** 5 1/4" & 8" Okonkolo  
**BA2:** 5 3/4" & 8 3/4" Itotele  
**BA3:** 6 3/4" & 12" Iya  
**MATERIALS** Premium fiberglass  
Hand selected buffalo heads  
**INCLUDES** Nylon strap; Tuning key

## 5 AFRICAN WOOD TALKING DRUMS

**SIZES** **M:** 7" diameter, 12" tall  
**L:** 8" diameter, 16" tall  
**PP ROPES** **M:** 3 mm thickness, 23 runners  
**L:** 3 mm thickness, 28 runners  
**MATERIALS** Mahogany Wood (*Swietenia macrophylla*)  
Hand selected goatskin heads  
**INCLUDES** Curved wooden beater

## 6 QUINTO IBO DRUM

**SIZE** Small  
**MATERIAL** Ceramic

**FEATURE** Built-in microphone hole  
**COLOUR** **WH:** White

## 7 FIBERGLASS TRI SOUND IBO DRUMS

**SIZE** Large  
**MATERIAL** Premium fiberglass  
**FEATURES** Built-in microphone hole  
**ID3GO:** Rawhide playing surface  
**ID4BKO:** Extra fiberglass playing surface  
**INCLUDES** Foam padded base  
**COLOUR** **BKO:** Black Ornament  
**GO:** Gold Ornament

## 8 FIBERGLASS LIQUID IBO DRUM

**SIZE** Large  
**MATERIAL** Premium fiberglass  
**FEATURES** Special bottom, filled with water; Built-in microphone hole  
**INCLUDES** Foam padded base  
**COLOUR** **BK/WH:** Black/White

# MINI & STANDARD DARBUKAS



## 1 MINI DARBUKAS

**SIZE** 4 1/4" diameter, 7 3/4" tall  
**MATERIALS** Aluminum shell; All-weather synthetic head  
**FEATURES** Fun to play and easy to carry; Great gift idea  
**HE-050:** Plain shell  
**HE-051:** Hand hammered shell  
**HE-052:** Hand engraved shell  
**HE-053:** Lacquered shell  
**INCLUDES** Tuning key

## 2 COPPER DARBUKAS, HAND ENGRAVED

**SIZES** **HE-204:** 7 1/2" diameter, 14 3/4" tall  
**HE-205:** 7 7/8" diameter, 15 1/2" tall  
**MATERIALS** Copper shell; Natural rawhide  
**FEATURE** Hand engraved shell  
**INCLUDES** Tuning key

## 3 COPPER DARBUKAS, BRASS PLATED, HAND HAMMERED

**SIZES** **HE-214:** 7 1/2" diameter, 14 3/4" tall  
**HE-215:** 7 7/8" diameter, 15 1/2" tall  
**MATERIALS** Copper shell; Synthetic head  
**INCLUDES** Tuning key

## 4 ALUMINUM DARBUKAS, HAND ENGRAVED

**SIZES** **HE-122:** 6 1/2" diameter, 12 3/4" tall  
**HE-124:** 8" diameter, 14 1/2" tall  
**MATERIALS** Aluminum shell; Synthetic head  
**INCLUDES** Tuning key

## 5 ALUMINUM JINGLE DARBUKAS, HAND HAMMERED

**SIZES** **HE-314:** 8" diameter, 14 1/2" tall  
**HE-315:** 8 1/4" diameter, 16" tall  
**MATERIALS** Aluminum shell; Synthetic head  
**FEATURES** Built-in jingles; Hand hammered shell  
**INCLUDES** Tuning key

## 6 ALUMINUM DARBUKAS, HAND HAMMERED

**SIZES** **HE-110:** 5 1/3" diameter, 9 1/4" tall  
**HE-111:** 5 7/8" diameter, 11" tall  
**HE-112:** 6 1/2" diameter, 12 3/4" tall  
**HE-113:** 7 1/4" diameter, 13 1/3" tall  
**HE-114:** 8" diameter, 14 1/2" tall  
**MATERIALS** Aluminum shell; Synthetic head  
**FEATURE** Hand hammered shell  
**INCLUDES** Tuning key

## 7 ALUMINUM DARBUKAS, PLAIN

**SIZES** **HE-100:** 5 1/3" diameter, 9 1/4" tall  
**HE-101:** 5 7/8" diameter, 11" tall  
**HE-102:** 6 1/2" diameter, 12 3/4" tall  
**HE-103:** 7 1/4" diameter, 13 1/3" tall  
**HE-104:** 8" diameter, 14 1/2" tall  
**MATERIALS** Aluminum shell; Synthetic head  
**INCLUDES** Tuning key



# ARTISAN EDITION, MINI & STANDARD DOUMBEKS



**1**

8 3/4", White  
**HEAD-136**

8 3/4", Black  
**HEAD-137**

8 3/4", Clear  
**HEAD-138**

**NEW**  
9", Clear  
**HEAD-142**

**2**

White Pearl, 8 3/4"  
**AEDD1**

White Pearl, 8 3/4"  
**AEDD2**

Blue Pearl, 8 3/4"  
**AEDD3**

White Pearl, 9"  
**AEDD4**

**3**

4"  
**HE-1030**

4"  
**HE-1018**

**4**

10"  
**HE-3218**

8 1/2"  
**HE-3018**

6"  
**HE-2018**

**HAND ENGRAVED SHELL**

8 1/2"  
**HE-3039**

**PAINTED FLORAL DESIGN**

**5**

8 1/2"  
**HE-3012**

**HAND ENGRAVED SHELL**

**6**

8 1/2"  
**HE-3030**

**HAND HAMMERED SHELL**

**7**

10"  
**HE-3200**

8 1/2"  
**HE-3000**

6"  
**HE-2000**

**LEATHERETTE COVERED SHELL**

**1 ARTISAN EDITION EGYPT DOUMBEK HEADS**

**SIZES** **HEAD-136, HEAD-137, HEAD-138:** 8 3/4" diameter  
**HEAD-142:** 9" diameter

**MATERIAL** Synthetic head

**FEATURES** Designed for the Meinl Artisan Edition Doumbeks

**COLOURS** **HEAD-136:** White; **HEAD-137:** Black; **HEAD-138, HEAD-142:** Clear

**2 ARTISAN EDITION EGYPT DOUMBEKS**

**SIZES** **AEDD1, AEDD2, AEDD3:** 8 3/4" diameter, 17" tall  
**AEDD4:** 9" diameter, 18 3/4" tall

**MATERIALS** Aluminum shell; Synthetic head; Mother of pearl inlays

**FEATURES** Authentic Egyptian mosaic inlays; Produces outstanding dums and taks (teks)

**INCLUDES** Tuning key

**DESIGNS** **AEDD1:** Mosaic Royale; **AEDD2:** Mosaic

Imperial; **AEDD3:** Mosaic Palace; **AEDD4:** Mosaic Queen

**3 MINI DOUMBEKS**

**SIZE** 4" diameter, 7 1/2" tall

**MATERIALS** Aluminum shell; Synthetic head

**FEATURES** **HE-1018:** Hand engraved shell  
**HE-1030:** Hand hammered shell

**INCLUDES** Tuning key

**4 ALUMINUM DOUMBEKS, HAND ENGRAVED**

**SIZES** **HE-2018:** 6" diameter, 12" tall (Soprano)  
**HE-3018, HE-3039:** 8 1/2" diameter, 17 1/8" tall  
**HE-3218:** 10" diameter, 18 1/4" tall (Bass)

**MATERIALS** Aluminum shell; Synthetic head

**FEATURES** **HE-2018:** High pitched articulate sounds  
**HE-3039:** Painted floral design  
**HE-3218:** Super deep tones

**INCLUDES** Tuning key

**5 COPPER DOUMBEK, HAND ENGRAVED**

**SIZE** 8 1/2" diameter, 17 1/8" tall

**MATERIALS** Copper shell; Synthetic head

**INCLUDES** Tuning key

**6 ALUMINUM DOUMBEK, HAND HAMMERED**

**SIZE** 8 1/2" diameter, 17 1/8" tall

**MATERIALS** Aluminum shell; Synthetic head

**INCLUDES** Tuning key

**7 ALUMINUM DOUMBEKS**

**SIZES** **HE-2000:** 6" diameter, 12" tall (Soprano)  
**HE-3000:** 8 1/2" diameter, 17 1/8" tall  
**HE-3200:** 10" diameter, 18 1/4" tall (Bass)

**MATERIALS** Aluminum shell (leatherette covered); Synthetic head

**FEATURES** **HE-2000:** High pitched articulate sounds  
**HE-3200:** Super deep tones

**INCLUDES** Tuning key

**COLOUR** Black

# HARDWARE

Our percussion hardware collection offers a wide range of sturdy stands, clamps, and accessories designed for durability and performance. Built to withstand the rigors of live shows and studio sessions, these pieces provide rock-solid support for your instruments, ensuring stability and precision. Whether you need adjustable conga stands, reliable clamps for your tambourines or shakers, or versatile mounts for your cymbals and drums, our hardware is crafted with high-quality materials to meet the demands of professional percussionists. Experience the confidence of using robust, well-engineered accessories that keep your setup secure and your focus on the music.

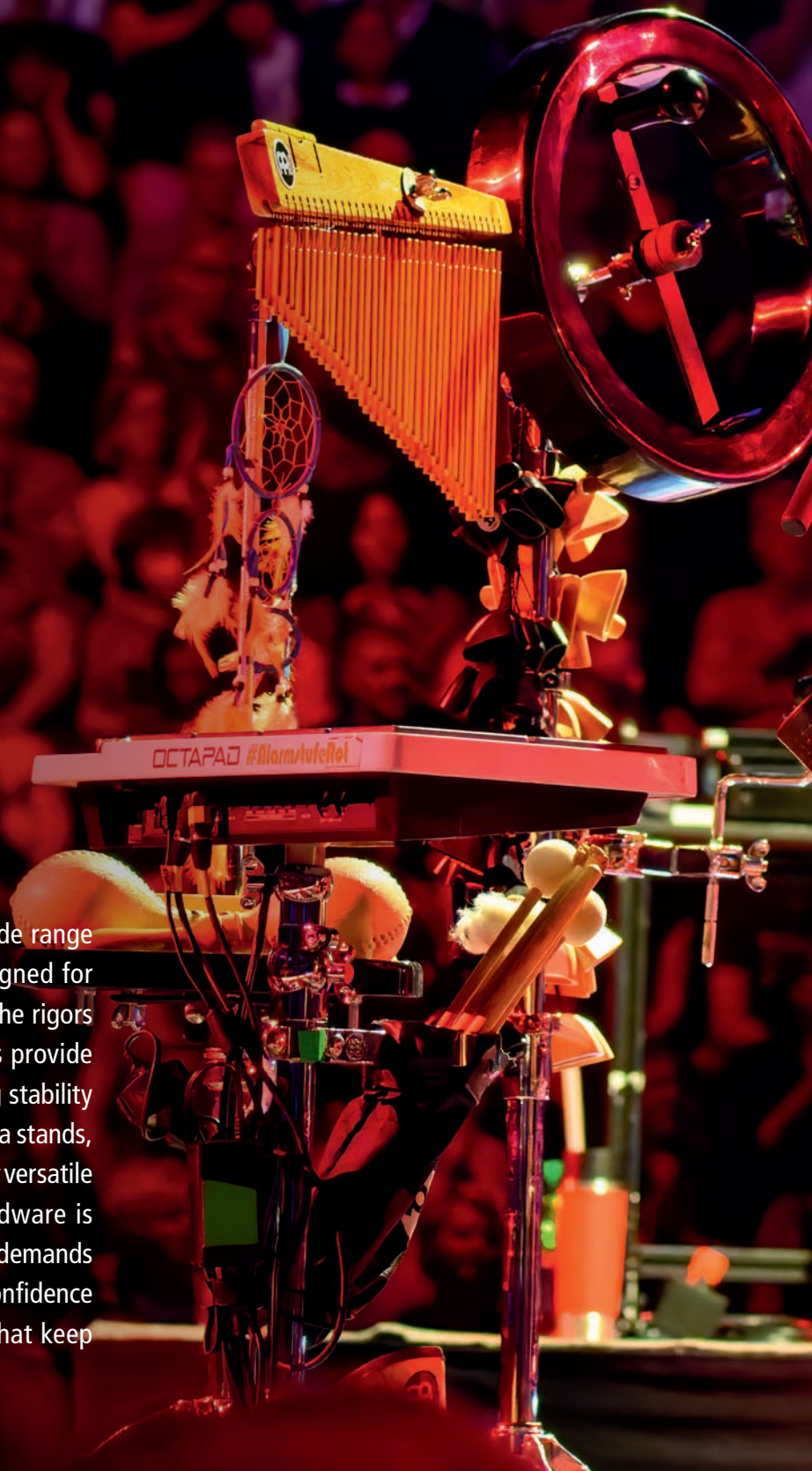



# STANDS

1



Black powder coated

### Black powder coated

For Marathon® Classic Series  
For Marathon® Designer Series  
For Luis Conte Artist Series  
**ST-MCC11BK:** 11"  
**ST-MCC1134BK:** 11 3/4"  
**ST-MCC1212BK:** 12 1/2"



Chrome plated

### Chrome plated

For Marathon® Exclusive Series  
**ST-MEC11CH:** 11"  
**ST-MEC1134CH:** 11 3/4"  
**ST-MEC1212CH:** 12 1/2"  
For Professional Series  
For Fibercraft Series  
**ST-MP11CH:** 11"  
**ST-MP1134CH:** 11 3/4"  
**ST-MP1212CH:** 12 1/2"  
For Floatune Series  
**ST-FL10CH:** 10"  
**ST-FL11CH:** 11"  
**ST-FL12CH:** 12"  
**ST-FL13CH:** 13"  
For Woodcraft Series  
**ST-WC11CH:** 11"  
**ST-WC1134CH:** 11 3/4"  
**ST-WC1212CH:** 12 1/2"

Gold tone

**QUICK AND EASY HEIGHT ADJUSTABILITY (DE PATENT)**

### Gold tone

For Marathon® Exclusive Series  
**ST-MEC11G:** 11"  
**ST-MEC1134G:** 11 3/4"  
**ST-MEC1212G:** 12 1/2"  
For Mongo Santamaria Artist Series  
**ST-MSA11G:** 11"  
**ST-MSA1134G:** 11 3/4"  
**ST-MSA1212G:** 12 1/2"

2

### EASY HEIGHT EXTENSION

Black powder coated  
**ST-HEBK**

Chrome plated  
**ST-HECH**

Gold tone  
**ST-HEG**



3



MIN. 43"  
MAX. 52 3/4"

For Headliner® congas  
**HDSTAND**

For MCC congas  
**TMDS**

4



For HDSTAND and TMDS  
**THBM**

**EASY MOUNTABLE**

6



Chrome plated  
**MCH-CH**

Gold tone  
**MCH-G**

**FOR ANY CONGA**

5



Chrome plated  
**TMPDS**

### 1 STEELY II CONGA STANDS (PATENTED)

**MATERIAL** Steel  
**FEATURES** Metal spike attachment on each leg  
L-shaped legs (DE, TH, US patent)  
U-shaped notch for quick set up and breakdown (US patent)  
Ergonomic arched rubber bracing for more stability (CN, DE, TH, US patent)  
Notches for quick height adjustability (DE patent)  
**INCLUDES** Hex key

### 2 STEELY II CONGA STAND HEIGHT EXPANDER SETS (DE PATENT)

**MATERIAL** Steel  
**FEATURE** Easy and effective height extension  
**INCLUDES** Mounting screws; Hex key  
**FINISHES** **BK:** Black powder coated  
**CH:** Chrome plated  
**G:** Gold tone

### 3 CONGA DOUBLE STANDS

**MATERIAL** Steel  
**FEATURES** Height adjustable  
Double braced tripod legs  
**INCLUDES** Hex key; Memory locks; Brackets; Set of screws, nuts, and washers; Mounting instructions

### 4 BONGO MOUNT

**MATERIAL** Chrome plated steel  
**FEATURES** Easy mountable on our conga double stands HDSTAND and TMDS  
Holds your bongo in place  
Adjustable angle

### 5 PROFESSIONAL CONGA DOUBLE STAND WITH WHEELS

**MATERIAL** Chrome plated steel

**FEATURES** Height adjustable  
Heavy construction  
Double braced tripod legs  
Lockable high-quality wheels  
Padded separators for adjustable angle  
Mounting instructions  
**INCLUDES** Two mounting brackets

### 6 CONGA HANDLES

**MATERIAL** Steel  
**FEATURES** Simple and safe add-on to help transport congas  
Easily mountable with instructional guide  
Fits any common conga  
Leaves sound unaffected  
**INCLUDES** Mounting screws and washers; Mounting instructions  
**FINISHES** **CH:** Chrome plated  
**G:** Gold tone

**7** STURDY LOCKABLE WHEELS MAKE IT EASY TO MOVE THE STAND INTO POSITION

Chrome plated  
**TMPC**

**8** THE LIGHTWEIGHT STAND CAN BE FOLDED TO A COMPACT UNIT WHICH REQUIRES LITTLE SPACE

Chrome plated  
**TMC-CH**

COMPATIBLE FOR ALL SIZES!

**9**

MIN. 34 1/2"  
MAX. 50"

Black powder coated  
**THBS-BK**

Chrome plated  
**THBS**

AN INNOVATIVE BRACKET DESIGN ENABLES QUICK SET UP (PATENTED)

**10** PADDED T-SHAPED TUBE FOR MORE STABILITY

MIN. 31 1/2"  
MAX. 52 3/4"

Chrome plated  
**TMB**

**11** A STABLE METAL CLAMP HOLDS THE ENTIRE UNIT IN PLACE

MIN. 12 1/4"  
MAX. 20"

Chrome plated  
**TMB-S**

LOW HEIGHT FOR SEATED PLAYERS

**12** PERFECT HEIGHT FOR CAJON PLAYERS

MIN. 22 3/4"  
MAX. 29 1/2"

Black powder coated  
**THBS-S-BK**

**13** DIFFERENT RODS FOR ALL NEEDS

MIN. 31 1/2"  
MAX. 52 1/2"

Chrome plated  
**TMPS**

**7 PROFESSIONAL CONGA STAND WITH WHEELS**

- MATERIAL** Chrome plated steel
- FEATURES** Adjustable padded stops fit any conga size  
Height adjustable legs  
Lockable wheels

- FEATURES** Quick set up  
Easy handling  
Reliable placement  
Double braced tripod stand  
Fits all common bongos
- INCLUDES** Wrench
- FINISHES** **THBS:** Chrome plated  
**THBS-BK:** Black powder coated

- FEATURES** Seated playing position possible  
Padded T-shaped tube  
Fully height and angle adjustable  
Double braced tripod legs  
Fits all common bongos
- INCLUDES** Hex key; Memory lock

**8 PROFESSIONAL CONGA STAND**

- MATERIAL** Chrome plated steel
- FEATURES** Unique design (DE patent)  
Rubber padded crossbeams  
Fully height adjustable  
Folds up to a compact unit
- INCLUDES** Hex key; Memory locks

**10 PROFESSIONAL BONGO STAND**

- MATERIAL** Chrome plated steel
- FEATURES** Padded T-shaped tube  
Fully height and angle adjustable  
Double braced tripod legs  
Fits all common bongos
- INCLUDES** Hex key; Memory locks

**12 CAJON HEIGHT BONGO STAND**

- MATERIAL** Black powder coated steel
- FEATURES** Quick set up  
Easy handling  
Perfect height for cajon players  
Fits all common bongos

**9 HEADLINER® SERIES BONGO STANDS (CN, DE, US PATENT)**

- MATERIAL** Steel











**11 PROFESSIONAL BONGO STAND FOR SEATED PLAYERS**

- MATERIAL** Chrome plated steel

**13 PERCUSSION STAND**

- MATERIAL** Chrome plated steel
- FEATURES** Height adjustable  
Double braced tripod legs
- INCLUDES** Hex key; Memory locks; 2 straight rods; 2 angled rods; 2 Z-shaped rods

# STANDS

<p><b>1</b> COLLAPSIBLE DESIGN</p>  <p>Black powder coated <b>STDJST-BK</b></p>	<p><b>2</b></p>  <p>QUICK AND EASY HEIGHT ADJUSTABILITY (DE PATENT)</p>  <p>Chrome plated <b>ST-DJEMBE</b></p>	<p><b>3</b> LENGTH ADJUSTABLE FOR VARIOUS DJEMBE SIZES</p>   <p>MIN. 23 1/2" MAX. 37 3/4"</p> <p>Chrome plated <b>TMD</b></p>	<p><b>4</b> FITS ALL CAJON SIZES</p>  <p>MIN. 26" MAX. 40 1/2"</p> <p>Black powder coated <b>TMCAJ</b></p>
<p><b>5</b></p>  <p><b>CMS</b></p>	<p>CAJON DRUM SET STANDS (SEE PAGE 53)</p>  <p><b>CHS CCS CAS</b></p>	<p><b>6</b></p>  <p>MIN. 22" MAX. 37"</p> <p>Black powder coated <b>CPTS</b></p>	<p><b>7</b> SPECIAL LOW HEIGHT</p>  <p>MIN. 29 1/2" MAX. 38"</p> <p>Chrome plated <b>MLH</b></p>

## 1 TRAVEL DJEMBE STAND

**MATERIAL** Black powder coated steel  
**FEATURES** Collapsible design  
Lightweight construction

## 2 STEELY II DJEMBE STAND (PATENTED)

**MATERIAL** Chrome plated steel  
**FEATURES** Metal spike attached to each leg  
L-shaped legs (DE, TH, US patent)  
U-shaped notch for quick set up and breakdown (US patent)  
Ergonomic arched rubber bracing for more stability (CN, DE, US patent)  
Notches for quick height adjustability (DE patent)  
Adapts to different djembe sizes  
**INCLUDES** Hex key, 3 spacers

## 3 PROFESSIONAL DJEMBE STAND

**MATERIAL** Chrome plated steel  
**FEATURES** Rubber padded hooks  
Fully height and angle adjustable  
Double braced tripod legs  
**INCLUDES** Hex key; Memory lock

## 4 PROFESSIONAL CAJON STAND

**MATERIAL** Steel  
**FEATURES** Quick set up  
Fully height and angle adjustable  
Double braced tripod stand  
Fits all cajon sizes

## 5 CAJON MICROPHONE STAND

**MATERIAL** Black powder coated aluminum  
**FEATURES** Round base for compact setup  
Solid construction  
Height adjustable

## 6 CAJON PICKUP TAPS STAND

**MATERIAL** Black powder coated aluminum  
**FEATURES** Designed to mount the Meinl Cajon Pickup Tom and Snare Taps  
Low-key stage footprint  
L-Shaped 3/8" rod  
Foldable legs, height adjustable

## 7 LOW HAT

**MATERIAL** Chrome plated steel  
**FEATURES** Special low height  
Made just for cajon players

## 8 TIMBALE STAND

**MATERIAL** Chrome plated steel  
**FEATURES** Double braced tripod base  
Height and angle adjustable  
Standard mounting rod for auxiliary percussion



**INCLUDES** Accessory pouch; L-shaped tuning key; Tune Up Oil

**9 PROFESSIONAL TIMBALE STAND**

**MATERIAL** Chrome plated steel  
**FEATURES** Heavy-duty double braced tripod base  
Height and angle adjustable  
Standard mounting rod for auxiliary percussion  
**INCLUDES** Accessory pouch; Tuning key; Tune Up Oil

**10 HAND-BALE STAND**

**MATERIAL** Chrome plated steel  
**FEATURES** Quick set up  
Rubber-tipped three arm basket  
Easy handling  
Double braced tripod stand

**11 PROFESSIONAL DOUMBЕК/IBO STAND**

**MATERIAL** Chrome plated steel  
**FEATURES** Foam padded ring  
Fully height and angle adjustable  
Double braced tripod legs  
**INCLUDES** Hex key; Memory lock

**12 DIDGERIDOO STAND**

**MATERIAL** Black powder coated aluminum  
**FEATURES** Steady support for your didgeridoo  
Stable tripod base  
Soft padding  
Rubber yoke for added protection  
**FINISH** Black

**13 PROFESSIONAL DIDGERIDOO STAND**

**MATERIAL** Black powder coated aluminum

**FEATURES** Dual leg base and strong aluminum construction  
Protective rubber yoke and soft padding  
Height and angle adjustable  
**FINISH** Black

**14 PRO DIDGERIDOO STAND**

**MATERIAL** Chrome plated steel  
**FEATURES** Play your didgeridoo in a seated or standing position  
Accommodates most didgeridoo sizes and shapes  
Padded rest with adjustable strap

**15 CHIMES STAND**

**MATERIAL** Chrome plated steel  
**FEATURES** Full angle and height adjustability  
Secure angle clamps  
Telescoping stem

# TABLES

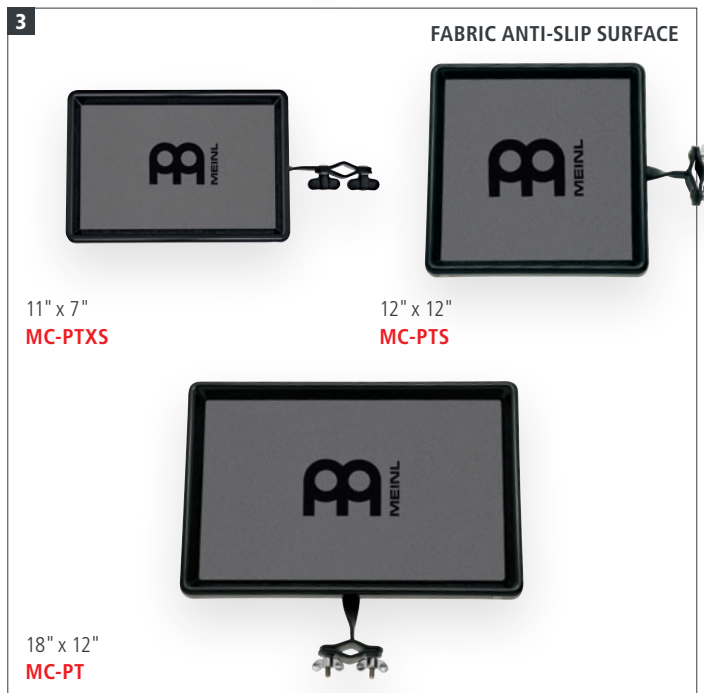

## 1 LAPTOP TABLE STAND

- SIZE** 20" x 12 1/2"
- MATERIAL** Perforated metal plate
- FEATURES** Holds laptops up to 17"  
Stoppers, hook and loop fastener to secure the laptop  
Holder for headphones  
Cord strain relief

## 2 LIGHT LAPTOP TABLE STAND

- SIZE** 14 1/2" x 10 3/4"
- MATERIAL** Aluminum
- FEATURES** Holds laptops up to 16"  
Fabric anti-slip surface  
Height adjustable  
Foldable legs

## 3 PERCUSSION TABLES

- SIZES** **MC-PT:** 18" x 12"  
**MC-PTS:** 12" x 12"  
**MC-PTXS:** 11" x 7"
- MATERIALS** **MC-PT, MC-PTS:** Premium fiberglass  
**MC-PTXS:** Synthetic
- FEATURES** Fabric anti-slip surface  
Adjustable angle  
Strong mounting clamp



4

HEIGHT ADJUSTABILITY AT ALL POINTS



Black powder coated  
TMPWS



5

ALL MEINL TRIPOD STANDS ARE EQUIPPED WITH MEMORY AND QUICK LOCKS



MIN. 30"  
MAX. 46 3/4"

16" x 22"  
TMPTS



4 PERCUSSION WORKSTATION

- MATERIAL** Black powder coated steel
- FEATURES** Fully height adjustable  
Angle adjustable top bar  
Heavy-duty construction  
Infinitely expandable  
Fabric anti-slip surfaces  
Colour doesn't interfere with stage lighting
- INCLUDES** 1 x Padded fiberglass percussion table, 22" x 24"  
2 x Padded fiberglass percussion tables, 18" x 12" (attachable)  
1 x Vertical bar, 30"  
2 x Vertical bars, 15" (attachable)  
4 x Straight rods with hook  
3 x Angled rods with hook  
1 x Z-shaped rod with hook

5 PERCUSSION TABLE STAND

- SIZE** 16" x 22"
- MATERIALS** Table: Premium fiberglass  
Stand: Chrome plated steel
- FEATURES** Fabric anti-slip surface  
Fully height adjustable  
Double braced tripod legs
- INCLUDES** Hex key  
Memory lock

# HARDWARE

<p><b>1</b> HOLDS TAMBOURINES AND SHAKERS</p>  <p>Mini Percussion Rack <b>MC-SHTA</b></p>	<p><b>2</b> PADDED SURFACE</p>  <p>Tambourine Holder <b>MC-TH</b></p>	<p><b>3</b> MIN. 1" MAX. 6"</p>  <p>Shaker Holder <b>MC-SH</b></p>	
<p><b>4</b> MIN. 2 1/2" MAX. 3 3/4"</p>  <p>Güiro Holder <b>MC-GU</b></p>	<p><b>5</b></p>  <p>Wood Block Holder <b>MWBH1</b></p>	<p><b>6</b></p>  <p>Standard Frame Drum Holder <b>MC-STFDH</b></p>	<p><b>7</b></p>  <p>Triangle Holder <b>MC-TRI</b></p>
<p><b>8</b></p>  <p>Triangle Clamp <b>CLAMP-TRI</b></p>	<p><b>9</b> FOR TURBO CABASA, MEDIUM</p>  <p>Cabasa Holder <b>MC-CA</b></p>	<p><b>10</b></p>  <p>Frame Drum Holder <b>MC-FDH</b></p>	
<p><b>11</b></p>  <p>Chimes Holders <b>MC-CH</b>      <b>MC-CHL</b></p>	<p><b>12</b></p>  <p>Drumstick Holders <b>MC-DSH</b>      <b>MC-DSH-JB</b></p>	<p><b>13</b></p>  <p>Bass Drum Cowbell Holders <b>MC-STBD</b>      <b>MC-BD</b></p>	

## 1 MINI PERCUSSION RACK

**MATERIALS** Black powder coated steel; Foam rubber  
**FEATURE** Holds tambourines and shakers  
**COLOUR** Black

## 2 TAMBOURINE HOLDER

**MATERIAL** Chrome plated steel  
**FEATURES** Rubber pads; Padded surface

## 3 SHAKER HOLDER

**MATERIAL** Chrome plated steel  
**FEATURES** Rubber pads; Length adjustable

## 4 GÜIRO HOLDER

**MATERIAL** Chrome plated steel  
**FEATURE** Rubber pads

## 5 WOOD BLOCK HOLDER

**MATERIAL** Chrome plated steel

## 6 STANDARD FRAME DRUM HOLDER

**MATERIAL** Chrome plated steel  
**FEATURE** Perfect for frame drums or traditional wood tambourines

## 7 TRIANGLE HOLDER

**MATERIAL** Chrome plated steel  
**FEATURES** Knurled surface; Nylon cord

## 8 TRIANGLE CLAMP

**MATERIAL** Chrome plated steel  
**FEATURES** Holds any triangle in place; Easy mountable

## 9 CABASA HOLDER

**MATERIAL** Chrome plated steel  
**FEATURES** Strong mounting clamp; Padded surface

## 10 FRAME DRUM HOLDER

**MATERIALS** Chrome plated steel; Anodized aluminum  
**FEATURE** Fully adjustable for any frame drum size

## 11 CHIMES HOLDERS

**SIZES** **MC-CH**: Regular  
**MC-CHL**: Large  
**MATERIAL** Chrome plated steel  
**FEATURES** Knurled surface; Foam washer

## 12 DRUMSTICK HOLDERS

**MATERIALS** Chrome plated steel; Black textile pouch  
**FEATURE** Strong mounting clamp  
**FINISHES** **MC-DSH**: Meinl  
**MC-DSH-JB**: Jawbreaker motif

## 13 BASS DRUM COWBELL HOLDERS

**MATERIALS** **MC-BD**: Chrome plated steel  
**MC-STBD**: Black powder coated steel  
**FEATURES** Rubber pads  
**MC-BD**: Fully adjustable  
**INCLUDES** **MC-BD**: L-shaped rod



Multi Clamp for Cymbal Stands  
**PMC-1**



Pedal Mount  
**PM-1**



Pedal Mount for Cymbals  
**PM-2**

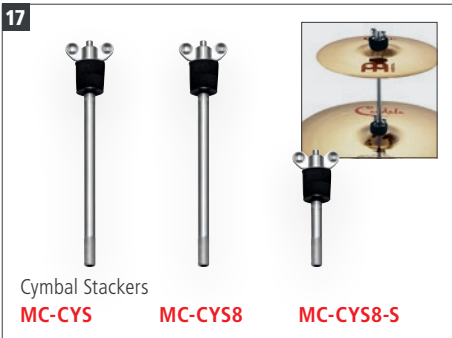

Cymbal Stackers  
**MC-CYS**    **MC-CYS8**    **MC-CYS8-S**

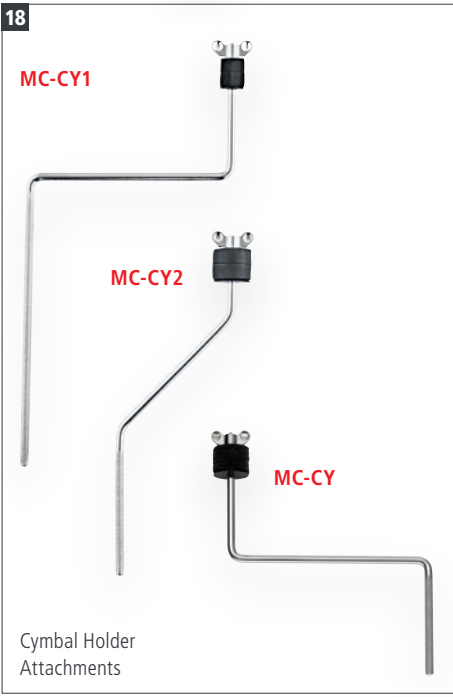

Cymbal Holder Attachments



Cymbal Attachment  
**MCA**



X-Hat Cymbal Stand Adapter  
**MXHA**

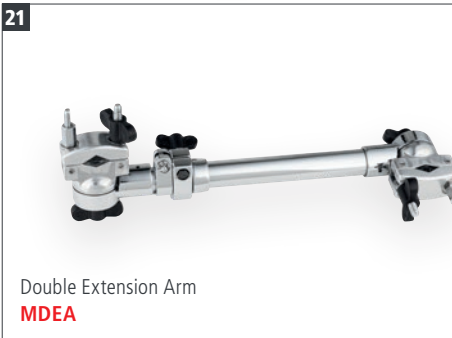

Double Extension Arm  
**MDEA**



X-Hat Auxiliary Hihat Arm  
**MXH**

**14 MULTI CLAMP FOR CYMBAL STANDS**

**MATERIAL** Chrome plated steel  
**FEATURES** Double-sided clamp; Attach a cymbal or tom arm to any stand; Universal for all standard drum hardware; Metal body with durable synthetic thumb screws

**15 PEDAL MOUNT**

**MATERIAL** Black powder coated steel  
**FEATURES** Height adjustable legs; Metal spikes; Fits on all common bass drum pedals and firmly holds cowbells, blocks, or tambourines  
**INCLUDES** 2 differently sized L-rods

**16 PEDAL MOUNT FOR CYMBALS**

**MATERIAL** Black powder coated steel  
**FEATURES** For foot activated cymbal crashes; Holds cymbals ranging from 16" to 22"  
**INCLUDES** Cymbal arm

**17 CYMBAL STACKERS**

**SIZES** **MC-CYS:** Ø 6 mm, long  
**MC-CYS8:** Ø 8 mm, long  
**MC-CYS8-S:** Ø 8 mm, short  
**MATERIAL** Chrome plated steel  
**FEATURE** Felt washers

**18 CYMBAL HOLDER ATTACHMENTS**

**MATERIAL** Chrome plated steel  
**FEATURES** Knurled surface; Felt washers; For splashes or small crashes; Easy placement on a drumkit, cajon set or percussion rig  
**MC-CY:** Z-shaped 3/8" rod  
**MC-CY1:** S-shaped 3/8" rod  
**MC-CY2:** Z-shaped 3/8" rod with extra-long knurled end

**19 X-HAT CYMBAL STAND ADAPTER**

**MATERIAL** Chrome plated steel  
**FEATURES** Turn any cymbal stand into an X-Hat stand; Fits 8 mm threaded cymbal stand posts; Use with any size hihat or stack

**20 CYMBAL ATTACHMENT**

**MATERIAL** Chrome plated steel  
**FEATURES** Multi-clamp; Cymbal boom arm

**21 DOUBLE EXTENSION ARM**

**MATERIAL** Chrome plated steel  
**FEATURES** Two points of 360-degree adjustability; Heavy-duty chrome plated steel; Length adjustable

**22 X-HAT AUXILIARY HIHAT ARM**

**MATERIAL** Chrome plated steel  
**FEATURE** Easy to attach and position at any height or angle

# HARDWARE



Mic. Cymbal Clamp Set  
**MPMCS**



Mic. Drumset Clamp Set  
**MPMDS**

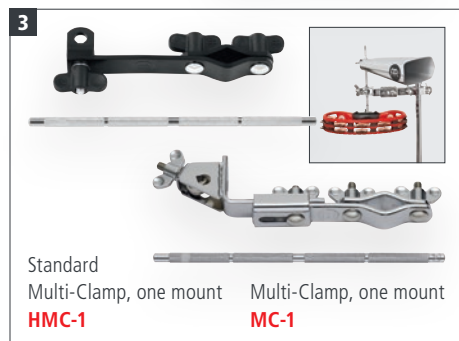

Standard Multi-Clamp, one mount  
**HMC-1** Multi-Clamp, one mount  
**MC-1**

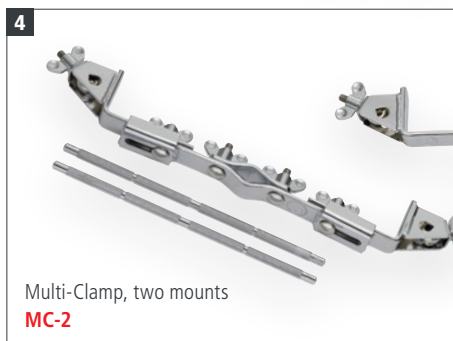

Multi-Clamp, two mounts  
**MC-2**

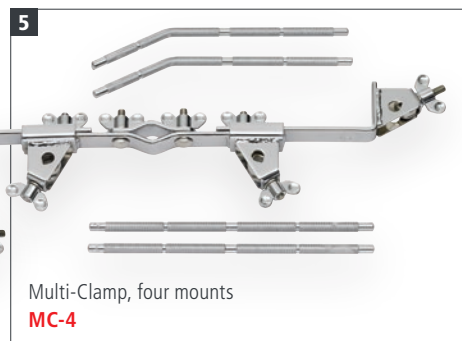

Multi-Clamp, four mounts  
**MC-4**

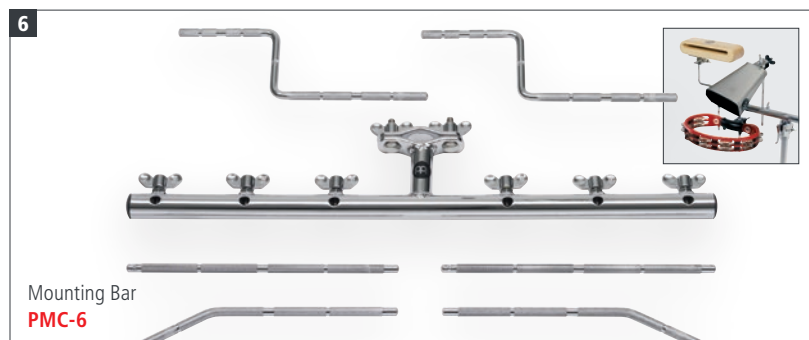

Mounting Bar  
**PMC-6**

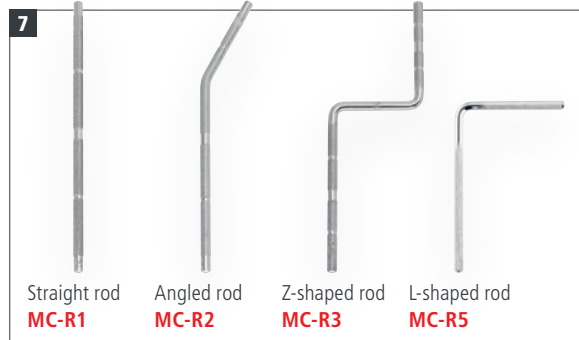

Straight rod  
**MC-R1** Angled rod  
**MC-R2** Z-shaped rod  
**MC-R3** L-shaped rod  
**MC-R5**

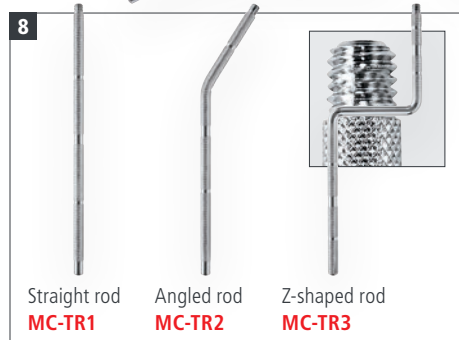

Straight rod  
**MC-TR1** Angled rod  
**MC-TR2** Z-shaped rod  
**MC-TR3**



Short rod  
**MC-MR1-S** Straight rod  
**MC-MR1** Angled rod  
**MC-MR2** Z-shaped rod  
**MC-MR3**

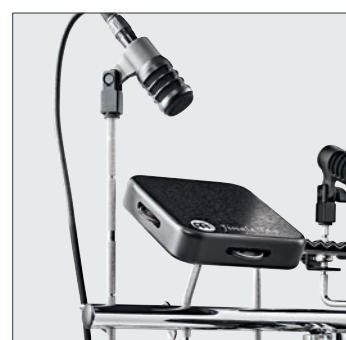

## 1 MICROPHONE CYMBAL CLAMP SET

**CONTAINS** 3 x Standard Multi-Clamp (HMC-1); 3 x Short Rod With Threaded Microphone Connector (MC-MR1-S); 1 x Microphone Rod Counter Nuts (MRCN5)

## 2 MICROPHONE DRUMSET CLAMP SET

**CONTAINS** 1 x Bass Drum Microphone Clamp (MC-MRBD); 4 x Rimclamp (RIMCLAMP-2); 4 x Short Rod With Threaded Microphone Connector (MC-MR1-S); 1 x Microphone Rod Counter Nuts (MRCN5)

## 3 MULTI-CLAMPS, ONE MOUNT

**MATERIALS** **HMC-1:** Black powder coated steel  
**MC-1:** Chrome plated steel  
**FEATURES** Strong mounting clamp  
**MC-1:** Length adjustable  
**INCLUDES** Straight rod

## 4 MULTI-CLAMP, TWO MOUNTS

**MATERIAL** Chrome plated steel  
**FEATURES** Length adjustable; Strong mounting clamp  
**INCLUDES** 2 straight rods

## 5 MULTI-CLAMP, FOUR MOUNTS

**MATERIAL** Chrome plated steel  
**FEATURES** Length adjustable; Strong mounting clamp  
**INCLUDES** 2 straight and 2 angled rods

## 6 MOUNTING BAR

**MATERIAL** Chrome plated steel  
**INCLUDES** 2 straight, 2 angled and 2 z-shaped rods

## 7 RODS

**MATERIAL** Chrome plated steel  
**FEATURES** Knurled surface; Available as a straight, angled, z-shaped, or l-shaped rod

## 8 THREADED PERCUSSION RODS

**MATERIAL** Chrome plated steel  
**FEATURE** Threaded tip to mount any standard 3/8" threaded percussion instrument

## 9 RODS WITH THREADED MICROPHONE CONNECTOR

**MATERIAL** Chrome plated steel  
**FEATURES** 3/8" diameter rod with threaded end; Designed to attach microphones; Use with the Meinl Rim Clamp; Available as a short, straight, angled, or z-shaped rod  
**INCLUDES** Microphone screw adapter

## 10 BASS DRUM MICROPHONE CLAMP

**MATERIAL** Chrome plated steel  
**FEATURE** U-shape 3/8" diameter rod with threaded end to attach a microphone



**10**  
Bass Drum  
Microphone Clamp  
**MC-MRBD**



**11**  
Set, 5 pcs.  
Microphone Rod Counter Nuts  
**MRCN5**



**12**  
Flexible Microphone Gooseneck  
**FMG**



**13**  
Microphone  
Cajon Clamp  
**MPMCC**



**14**  
Microphone  
Adapter  
**TMMA**



**15**  
Clamp  
**CLAMP**



**16**  
Rim Clamps  
**RIMCLAMP-2**

**RIMCLAMP**



**RIMCLAMP-M**

PERFECT MIC PLACEMENT ON ANY COMMON DRUM RIM



**17**  
Professional Multi-Clamps  
**TMPMC**

**TMPMC-R**



**TMPMC-G**

STRONG CLAMP SECURES TO ANY DRUM RIM

**11 MICROPHONE ROD COUNTER NUTS**

**MATERIAL** Black powder coated steel  
**FEATURES** Set of 5 counter nuts; Securely lock your microphone attachments

**12 FLEXIBLE MICROPHONE GOOSENECK**

**SIZE** 12.8" (32.5 cm)  
**MATERIAL** Metal  
**FEATURES** Optimal microphone placement; No additional stand required; Fits in the Meinl Rim Clamp; 3/8" and 5/8" threads

**13 MICROPHONE CAJON CLAMP**

**MATERIAL** Steel  
**FEATURE** Foam padding ensures quiet recording

**14 MICROPHONE ADAPTER**

**MATERIAL** Chrome plated steel  
**FEATURES** Turns your cymbal stand into a microphone stand; 8 mm threaded attachment

**INCLUDES** 5/8" male to 3/8" mic screw adapter

**15 CLAMP**

**MATERIAL** Chrome plated steel  
**FEATURE** Compact and solid design

**16 RIM CLAMPS**

**MATERIALS** Black powder coated steel  
**RIMCLAMP:** Chrome plated steel (L-shaped rod)  
**RIMCLAMP-M:** Metal (Gooseneck)  
**FEATURES** Fully height and angle adjustable; Fits to any common drum rim  
**RIMCLAMP, RIMCLAMP-2:** Holds percussion accessories right where you need them  
**RIMCLAMP-M:** Works with all 3/8" or 5/8" mic clips (Mic clip not included)

**INCLUDES** **RIMCLAMP:** L-shaped rod  
**RIMCLAMP-M:** Flexible Microphone Gooseneck

**17 PROFESSIONAL MULTI-CLAMPS**

**MATERIALS** Black powder coated die cast steel  
**TMPMC-G:** Metal (Gooseneck)  
**TMPMC-R:** Chrome plated steel (Z-shaped rod)  
**FEATURES** 360-degree adjustable 3/8" rod eye bolt mount  
**TMPMC:** Strong clamp secures to any drum set or percussion rim  
**TMPMC-G:** Removable flexible microphone gooseneck; Strong clamp secures to any drum set or percussion rim  
**TMPMC-R:** Removable Z-shaped 3/8" rod to mount percussion instruments

# STICKS, BEATERS, BRUSHES, MALLETS & SCRAPERS

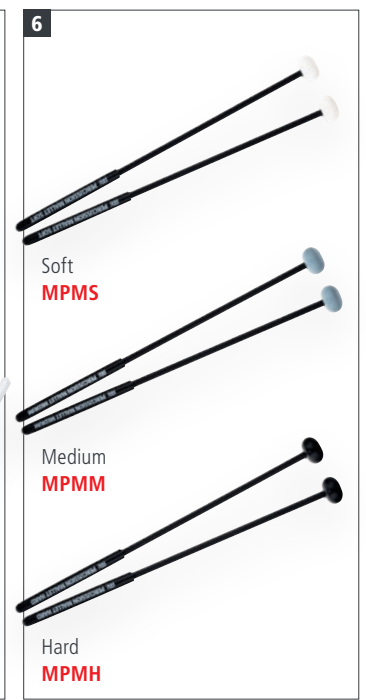
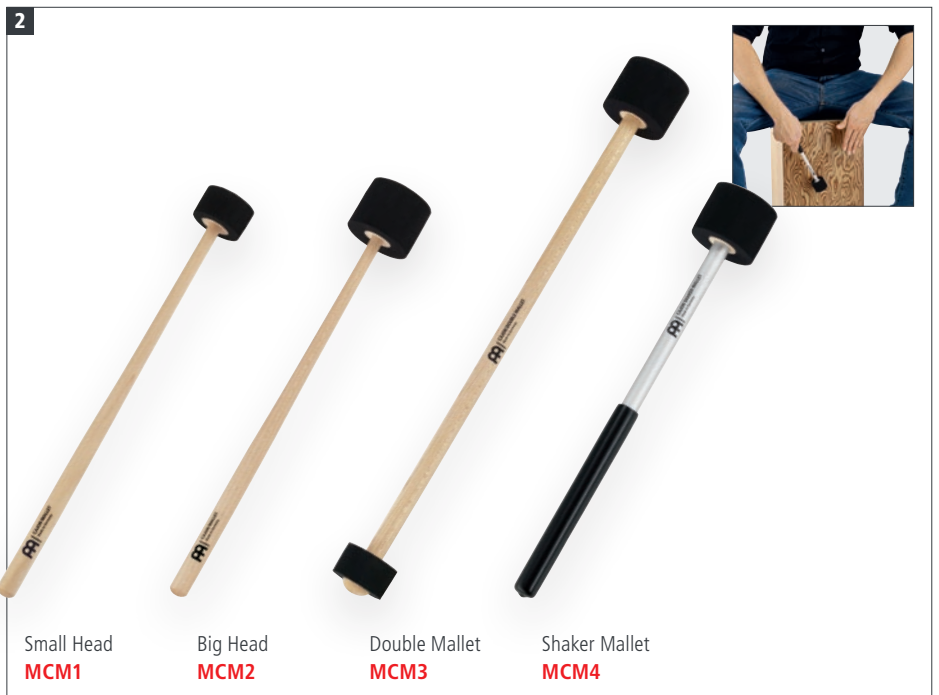

## 1 BASS BEAT CAJON BRUSH

**SIZE** 13" long  
**MATERIALS** Polymer bristles  
Foam rubber  
**FEATURES** Straight polymer bristles for ultra-smooth precision; Soft foam rubber for full-bodied low notes; Two adjustable control rings; Flexible handle

## 2 CAJON MALLET COLLECTION

**SIZES** **MCM1, MCM4:** 11 3/4" long  
**MCM2:** 12 1/4" long  
**MCM3:** 15 1/2" long  
**MATERIALS** Foam rubber  
**MCM1, MCM2, MCM3:** Hard maple  
**MCM4:** Aluminum  
**FEATURES** Made in Germany  
**MCM1:** Made out of the finest hand-selected maple; Small foam rubber head; Designed for softer playing  
**MCM2:** Made out of the finest hand-selected maple; Extra thick foam rubber head  
**MCM3:** Made out of the finest hand-selected maple; Foam rubber padding; Two different ends for contrasting sounds  
**MCM4:** Integrated shaker effect in handle; Soft foam rubber head; Lightweight aluminum handle

## 3 TAMBORIM STICKS

**MATERIAL** Synthetic  
**COLOURS** **BK:** Black  
**R:** Red

## 4 BODHRAN TIPPERS

**MATERIAL** Ash Wood  
**COLOUR** Antique Brown

## 5 SAMBA STICKS

**SIZES** **SST1-S:** Stick, short version  
**SST1-R:** Stick, medium version  
**SST1-L:** Stick, long version  
**SST3-S:** Triple stick, short version  
**SST3:** Triple stick  
**MATERIAL** Synthetic



**7**

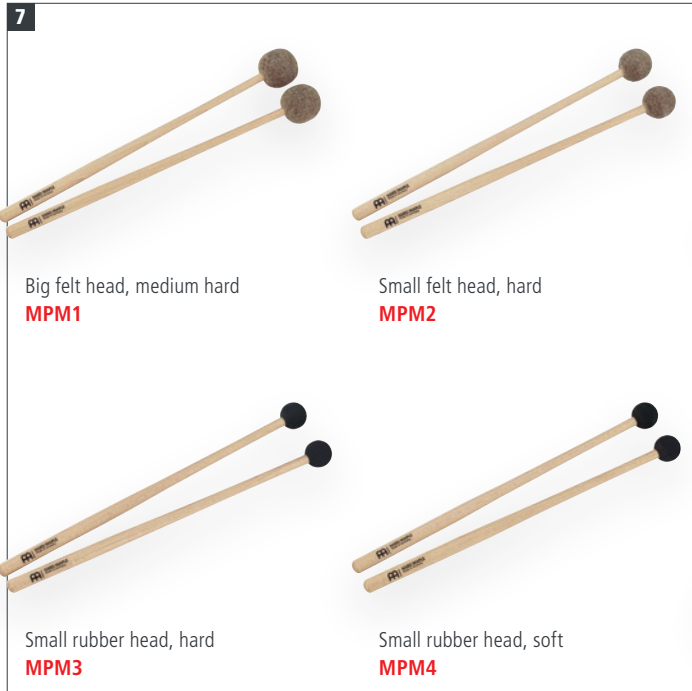

Big felt head, medium hard  
**MPM1**

Small felt head, hard  
**MPM2**

Small rubber head, hard  
**MPM3**

Small rubber head, soft  
**MPM4**

**8**



American Hickory  
**MPM5**

**9** **NEW**



High-strength synthetic  
**COW5**

**10**



Siam Oak  
**COW1**

Molded ABS  
**COW3BK**

Siam Oak  
**COW1BK**

Siam Oak  
**COW2**

**PADDED BEATER SECTION**

**11**



2" felt beater  
**SB1**

2" felt beater  
**SB2**

2 1/2" felt beater  
**SB3**

2" leather beater  
**SB4**

3" bushy felt beater  
**SB5**

**12**



**SBH**

**13**

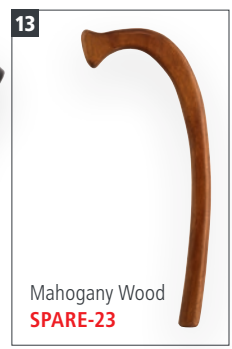

Mahogany Wood  
**SPARE-23**

**14**



Wood  
**MGS1**

ABS  
**MGS2**

**6 MOLDED ABS PERCUSSION MALLETS**  
 SIZE 12 1/4" long  
 MATERIAL Durable molded ABS  
 FEATURES Easy to play across many different percussion instrument types  
**MPMS:** Soft  
**MPMM:** Medium  
**MPMH:** Hard

**7 PERCUSSION MALLETS**  
 SIZE 12 1/2" long  
 MATERIALS Hard maple  
**MPM1:** Big felt head, medium hard  
**MPM2:** Small felt head, hard  
**MPM3:** Small rubber head, hard  
**MPM4:** Small rubber head, soft  
 FEATURES Made out of the finest hand-selected maple; Great for woodblocks and synthetic percussion blocks; Made in Germany

**8 TEMPLE & WOOD BLOCK MALLETS**  
 SIZE 12 1/2" long  
 MATERIAL American Hickory  
 FEATURES Soft rubber mallet heads for wood blocks; Solid hickory handles

**9 PALO COWBELL BEATER**  
 SIZE 9 1/2" long  
 MATERIAL High-strength synthetic  
 FEATURES Cutting tone; High-strength; Balanced weight; Rubber grip; For live and studio

**10 COWBELL BEATERS**  
 MATERIALS **COW1, COW2:** Siam Oak (*Hevea brasiliensis* Muell.-Arg.)  
**COW3:** Molded ABS  
 FEATURES Ribbed grip; Durable construction

**11 SAMBA BEATERS**  
 SIZES **SB1:** 15" long  
**SB2, SB3, SB4, SB5:** 16" long  
 MATERIALS **SB1:** Aluminum stick with 2" felt beater  
**SB2:** Wood stick with 2" felt beater  
**SB3:** Wood stick with 2 1/2" felt beater  
**SB4:** Wood stick with 2" leather beater  
**SB5:** Wood stick with 3" bushy felt beater

**12 SURDO BEATER HOLDER**  
 MATERIAL Leather  
 COLOUR Black

**13 TALKING DRUM BEATER**  
 MATERIAL Mahogany Wood

**14 GÜIRA SCRAPERS**  
 MATERIALS Steel rods  
**MGS1:** Ergonomic wooden grip  
**MGS2:** Sanded ABS grip

# BAGS



## BAGS

**MATERIAL** Heavy-duty nylon (unless noted otherwise)

### 1 CAJON GIG BAG

**SIZE** 20 1/2" W x 12" H x 12" D

**FEATURE** Carrying grip

### 2 PROFESSIONAL CAJON BAGS

**SIZES** **MCJB:** 20 1/2" W x 12" H x 12" D

**MCJB-L:** 23 1/2" W x 17" H x 15" D

**FEATURES** Padded shoulder strap; External pocket; Carrying grip

**MCJB-L:** Fits bigger sized cajons

### 3 DELUXE CAJON BAG

**SIZE** 20 1/2" W x 12" H x 12" D

**FEATURES** Synthetic fur; Padded shoulder strap; External pocket; Carrying grip

### 4 DELUXE BASS PEDAL CAJON BAG

**SIZE** 21 1/2" W x 17" H x 14 1/2" D

**FEATURES** Synthetic fur; Padded shoulder strap; External pocket; Carrying grip

### 5 CAJON BACKPACK

**SIZE** 13 1/2" W x 19 3/4" H x 14" D

**FEATURES** Backpack; Carrying grip

### 6 JAM CAJON GIG BAG

**SIZE** 12" W x 16" H x 12" D

**FEATURES** Fits all Jam Cajon models; Strong carrying grip; Two-way zipper

### 7 TRAVEL CAJON GIG BAG

**SIZE** 12"

**FEATURES** Double-slide zipper; Carrying grip

### 8 PROFESSIONAL SLAPTOP CAJON BAG

**SIZE** 23" W x 15" H x 13" D

**FEATURES** Padded shoulder strap; External pocket; Carrying grip

### 9 CAIXON & CAIXONET BAG

**SIZE** 31" W x 12 1/2" H x 13 1/2" D

**FEATURES** Carrying handle with reinforced nylon stitching; Durable zipper; Adjustable shoulder strap; Fits caiXoN and caiXoNet stacked or individual

**FEATURES** Padded shoulder strap; Carrying grip

### 10 PROFESSIONAL HYBRID SLAPTOP CAJON BAG

**SIZE** 17 1/2" W x 13" H x 8" D





**11 MULTI-PERCUSSION BAG**  
 SIZE 21" W x 12" H x 15" D  
 FEATURES Padded shoulder strap; External pocket; Carrying grip; Padded dividers

**12 STANDARD DJEMBE BAGS**  
 SIZES **MSTDJB10**: Medium (10")  
**MSTDJB12**: Large (12")  
 FEATURES External pocket; Carrying grip

**13 PROFESSIONAL DJEMBE BAGS**  
 SIZES **S**: Small (up to 10")  
**M**: Medium (up to 12")  
**L**: Large (up to 13 1/2")  
**XL**: XL: Extra large (up to 14")  
 FEATURES External pocket; Carrying grip  
**MDJB-M, MDJB-L, MDJB-XL**: Padded backpack straps

**14 DJEMBE GIG BAG**  
 FEATURES Carrying grip; Shoulder strap; Outer pocket

**15 POP OFF DJEMBE BAGS**  
 SIZES **VR-DJB-9**: 11 1/2" x 17 1/4"  
**VR-DJB-10**: 11 3/4" x 19 3/4"  
**VR-DJB-12**: 13 3/4" x 24 1/2"  
**VR-DJB-14**: 15 3/4" x 27 1/2"  
 FEATURES Carrying handle with reinforced nylon stitching; Durable zipper; Adjustable backpack straps  
**VR-DJB-9** Holds 8" & 9" diameter djembes  
**VR-DJB-10** Holds 10" diameter djembes  
**VR-DJB-12** Holds 12" diameter djembes  
**VR-DJB-14** Holds 14" diameter djembes

**16 PROFESSIONAL DJEMBE CAPS**  
 SIZES **M**: 10"; **L**: 12"; **XL**: 13"

**17 CONGA GIG BAG**  
 FEATURES Carrying grip; Shoulder strap; Outer pocket

**18 PROFESSIONAL CONGA BAGS**  
 SIZES **MCOB-11**: 11"  
**MCOB-1134**: 11 3/4"  
**MCOB-1212**: 12 1/2"  
 FEATURES Additional upright zipper; External pocket; Padded backpack straps; Carrying grip

**19 POP OFF CONGA SET BAG**  
 SIZE 13" x 26"  
 FEATURES Carrying handle with reinforced nylon stitching; Durable zipper; Adjustable backpack straps; Carry all three sizes of Meinl Pop Off Congas

# BAGS



## BAGS

**MATERIAL** Heavy-duty nylon (unless noted otherwise)

### 1 BONGO GIG BAG

**SIZE** Bongos up to 7 1/2" Macho & 8 1/2" Hembra  
**FEATURE** Carrying grip

### 2 PROFESSIONAL BONGO BAG

**FEATURES** Additional room for accessories; Padded shoulder strap; Carrying grip; Padded separator

### 3 PROFESSIONAL TIMBALES BAG

**SIZE** 14" & 15"  
**FEATURES** External pocket for stand and cowbell; Padded shoulder strap; Carrying grip; Padded separator

### 4 PROFESSIONAL SURDO BAGS

**SIZES** **MSUB-16:** 16" x 20"  
**MSUB-18:** 18" x 22"  
**MSUB-20:** 20" x 24"  
**MSUB-22:** 22" x 24"  
**FEATURES** Double-slide zipper; Padded backpack straps; Carrying grip; External pocket

### 5 PROFESSIONAL TIMBA BAGS

**SIZES** **MTIMB-1428:** 14" x 28"  
**MTIMB-1435:** 14" x 35"  
**FEATURES** Double-slide zipper; Padded backpack straps; Carrying grip; External pocket

### 6 STACK DRUM SET BAG

**SIZE** 13 1/2" x 24 1/2"  
**FEATURES** Carrying handle with reinforced nylon stitching; Durable zipper; Adjustable backpack straps; Carry both sizes of Meinl Stack Drum Set

### 7 POP OFF BASS DRUM SET BAG

**SIZE** 16 1/4" x 25 1/4"  
**FEATURES** Carrying handle with reinforced nylon stitching; Durable zipper; Adjustable backpack straps; Carry all three sizes of Meinl Pop Off Bass Drums

### 8 PROFESSIONAL TANTAM BAG

**SIZE** 14" x 28"  
**FEATURES** Double-slide zipper; Padded backpack straps; Carrying grip; External pocket

### 9 PROFESSIONAL REBOLO BAG

**SIZE** 12" x 18"  
**FEATURES** Double-slide zipper; Padded shoulder strap; Carrying grip; External pocket

### 10 PROFESSIONAL REPINIQUE BAGS

**SIZES** **MREB-10:** 10" x 10"  
**MREB-12:** 12" x 12"



PRO REPINIQUE BAGS

MREB-10 MREB-12



PRO CUIÇA BAGS

MQW-6 MQW-10



PRO CAIXA BAGS

MCA-12 MCA-12T MCA-14



PRO CHIMES BAG

MCHB



PRO FRAME DRUM BAGS

MFDB-14 MFDB-16 MFDB-18 MFDB-20 MFDB-22



PRO DEEP SHELL FRAME DRUM BAGS

MFDB-12BE MFDB-14BE MFDB-14IBO MFDB-18BO MFDB-22-D



PRO PANDEIRO BAGS

MPAB-10 MPAB-12



TAMBOURINE GIG BAG

MSTTB



PRO TAMBORIM BAG

MTAB-06



PRO KANJIRA BAG

MFDB-7KA

**FEATURES** Double-slide zipper; Shoulder strap; Carrying grip; External pocket

**11 PROFESSIONAL CUIÇA BAGS**

**SIZES** MQW-6: 6"  
MQW-10: 10"

**FEATURES** Padded shoulder strap; Carrying grip; External pocket

**12 PROFESSIONAL CAIXA BAGS**

**SIZES** MCA-12: 12" x 4 1/2"  
MCA-12T: 12" x 6"  
MCA-14: 14" x 4"

**FEATURES** Double-slide zipper; Shoulder strap; Extra pocket for spare heads; Carrying grip; External pocket

**13 PROFESSIONAL CHIMES BAG**

**FEATURES** Stores up to 2 chimes; Carrying grip; Inner hook and loop fastener straps;

2 internal pockets

**14 PROFESSIONAL FRAME DRUM BAGS**

**SIZES** MFDB-14: 14", 2 1/2" deep  
MFDB-16: 16", 2 1/2" deep  
MFDB-18: 18", 2 1/2" deep  
MFDB-20: 20", 2 1/2" deep  
MFDB-22: 22", 2 1/2" deep

**FEATURES** Double-slide zipper; Shoulder strap; Carrying grip

**15 PROFESSIONAL DEEP SHELL FRAME DRUM BAGS**

**SIZES** MFDB-12BE: 12" x 4"  
MFDB-14BE: 14" x 4"  
MFDB-14IBO: 14" x 6"  
MFDB-18BO: 18" x 4"  
MFDB-22-D: 22" x 4"

**FEATURES** Double-slide zipper; Shoulder strap; Carrying grip

**16 PROFESSIONAL PANDEIRO BAGS**

**SIZES** MPAB-10: 10"; MPAB-12: 12"

**FEATURES** Double-slide zipper; Shoulder strap; External pocket  
MPAB-12: Also fits for our 10" Tambourines

**17 TAMBOURINE GIG BAG**

**SIZE** 10"  
**FEATURES** Sturdy zipper; Carrying grip

**18 PROFESSIONAL TAMBORIM BAG**

**SIZE** 6"  
**FEATURES** Double-slide zipper; Shoulder strap; External pocket

**19 PROFESSIONAL KANJIRA BAG**

**SIZE** 8 1/2" x 2 1/2"  
**FEATURES** Double-slide zipper; Shoulder strap; External pocket

# BAGS



## BAGS

**MATERIAL** Heavy-duty nylon  
(unless noted otherwise)

### 1 STANDARD DARBUKA BAG

**SIZE** Medium  
**FEATURES** Carrying grip; Shoulder strap; Outer pocket

### 2 PROFESSIONAL DARBUKA BAG

**FEATURES** Double-slide zipper; Additional upright zipper; Padded shoulder strap; Carrying grip; External pocket

### 3 PROFESSIONAL IBO BAGS

**SIZES** **S:** Small (9 3/4" W x 13 1/3" H x 9 3/4" D)  
**M:** Medium (11" W x 14 1/2" H x 11" D)  
**L:** Large (11 3/4" W x 15" H x 11 3/4" D)  
**FEATURES** Padded shoulder strap; Carrying grip; External pocket

### 4 STANDARD DOUMBЕК BAG

**SIZE** Medium  
**FEATURES** Carrying grip; Shoulder strap; Outer pocket

### 5 PROFESSIONAL DOUMBЕК BAGS

**SIZES** **MDOB:** Medium  
**MDOB-L:** Large  
**FEATURES** Double-slide zipper; Additional upright zipper; Padded shoulder strap; Carrying grip; External pocket

### 6 STRAIGHT DIDGERIDOO BAG

**SIZE** 53"  
**FEATURES** Padded shoulder strap; External pocket

### 7 PRO DIDGERIDOO BAG

**SIZE** 58"  
**FEATURES** Padded shoulder strap; External pocket

### 8 PERCUSSION BACKPACK

**MATERIAL** Ripstop Fabric  
**FEATURES** Travel backpack for small percussion instruments; Numerous pockets on the inside and outside; Padded backpack shoulder straps; Carrying grip  
**FINISH** Carbon Grey

### 9 HAND PERCUSSION BAGS

**SIZES** **M:** Medium  
**L:** Large  
**FEATURES** Great for cowbells, blocks or small hand percussion; Drawstring top; Durable nylon prevents scuffs and scratches; No hassle storage or travel

### 10 COMPACT STICK BAG

**FEATURE** Carrying grip

# BAGS & DRUM RUGS



COMPACT STICK BAG

MCSB



PROFESSIONAL STICK BAG

MSB-1



DELUXE STICK BAG

MDLXSB



STICK SLING BAG

MSSB



DRUM RUGS



Black, small  
MDRS-BK

Black, large  
MDRL-BK

Oriental, small  
MDRS-OR

Oriental, large  
MDRL-OR

## 11 PROFESSIONAL STICK BAG

**FEATURES** External pockets; Shoulder straps; Extension straps

**COLOUR** Black

## 12 DELUXE STICK BAG

**MATERIAL** Padded synthetic leather

**FEATURES** External pockets; Shoulder straps; Elastic cord attachments

## 13 STICK SLING BAG

**FEATURES** Wider version of our Professional Stick Bag; Eleven internal pockets of varying size for any kind of stick, mallet, rod, brush or accessory; Oversized exterior pocket that can fit books, sheet music, practice pads or metronomes

## 14 DRUM RUGS

**SIZES** **MDRS:** 5.25 ft (160 cm) x 4.6 ft (140 cm)  
**MDRL:** 6.5 ft (200 cm) x 6.5 ft (200 cm)

**MATERIAL** Woven fabric

**FEATURES** **MDRS**

Tightly woven fabric creates a strong grip with spurs and stands; Durable no-slip rubber bottom; Compact size for smaller drum or percussion setups; Ideal for smaller stage footprint

**MDRL**

Durable no-slip rubber bottom; Full-size for any drum or percussion setup; Ideal for drum risers

**INCLUDES** Travel bag  
Strap

**FINISHES** **BK:** Black  
**OR:** Oriental

# MEINL PERCUSSION ONLINE



## DISCLAIMER

All features are subject to change without notice. Not responsible for typographic errors. No part of this book may be reprinted, reproduced, or included in any online service in any form in whole or in part, without the prior permission of Meinel.

© 2025 Roland Meinel Musikinstrumente GmbH & Co. KG

### ADVERTISING CONCEPT & DESIGN

ercas GmbH & Co. KG [ercasdieagentur.de]

### CONTENT & DIRECTION

Hannes Auerochs, Udo Heubeck

### COPYWRITING

Hannes Auerochs, Ayrton Gauerke

### PHOTOGRAPHY

Christian Habermeier, Sebastian Jäger, Angelika Jakobs [studio-waldeck.de]

Miroslav Šmikmátor [smikmatorphoto.com]

Tobias Winklmann, Danny Lucenara, Hannes Auerochs, Manuel Burdeus Mendoza, Jan Potsch, Niklas Sakowski, Thomas Bönig, Paul Höppner, Christian Schemm, Mario Schmitt, William De La Cruz, Dennis Ostermann, Rüdiger Knuth

### LITHOGRAPHY

Sven Mihm [mihm-werbung.de]

### GLOBAL HEADQUARTERS

Roland Meinel Musikinstrumente GmbH & Co. KG  
Musik-Meinel-Straße 1  
91468 Gutenstetten  
Germany

### US HEADQUARTERS

Meinel USA L.C.  
3427 Ambrose Avenue  
Nashville, TN 37207  
USA

### INVENTORS OF SELECTED PRODUCTS

Bill Saragosa  
Dany Moreno  
Gilson Batista Da Silveira  
José J. Cortijo  
Juan Carlos Melian  
Marcus Ralph De Mowbray  
Mark Allen Johnson  
Michael Buchner  
Reiko Guthschmidt  
Taku Hirano  
Torsten Franz

REMO®, Fiberskyn®, Nuskyn® and Skyndeeep® are registered trademarks of REMO® Inc. Used by permission.

This catalogue has been printed on climate neutral paper.

Printed in Germany M-CA201024

